

**CONECTORES
CIRCULARES
SERIE NR**



SUMINISTROS INDUSTRIALES MP4 S.L.

TEL. +34 93 590 94 77

c/Adrià Gual, 10 local 2

08173 Sant Cugat del Vallès • Barcelona (Spain)

www.suministros-industriales.es

e-mail: mp4@suministros-industriales.es

Circular Connectors NR Series



Be certain. Belden.

Robust Circular Connectors to DIN EN 175201-804

Impact-resistant, shatter-proof, fiberglass-reinforced housing – the NR series housing is almost indestructible. In addition to being extremely robust, these circular connectors are compact and available in various designs, making them very versatile.

Product Features

- Shock and vibration-proof
- IP65 protection
- Watertight, IP67 protection versions
- Shielded and unshielded versions

Benefits



- Time and cost saving during installation by using crimp contacts
- High flexibility through the large number of different housings for a wide range of applications
- Robust housing and high-quality contact surfaces ensure a long service life for the connectors and therefore maximum productivity

Applications







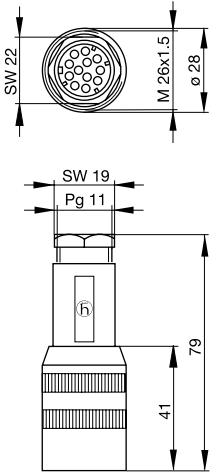
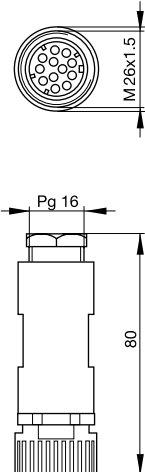
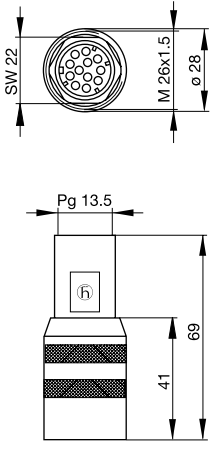





- Connection of compactors and conveyor systems
- Transmission of control pulses, such as in hydraulics and pneumatics
- Powering of machine tools
- Connection of small drives and pump motors

Circular Connectors NR Series

Technical Information

Product Description			
Order Designation	NxR EF	N11R EF F	NxR EFS
			
Description	Circular cable connector, female, straight, strain relief via clamping cage, spring-loaded female contacts, 6 to 11-pin, PG11 cable screw coupling	Circular cable connector, female, straight, strain relief via clamping cage, spring-loaded female contacts, 11-pin, PG16 cable screw coupling	Circular cable connector, female, straight, shielded, strain relief via clamping cage, spring-loaded female contacts, 6 to 11-pin, PG13.5 cable screw coupling
(Construction Type) Standard	DIN EN 175201-804, EF design		
Technical Data			
Ambient Temperature	-40 °C to +90 °C		
Housing Material/Grip	PBT GF (threading: AIMgSi)	PBT GF (threading: PA 66)	Zinc die casting, nickel-plated (thread: CuZn, nickel-plated)
Contact Holder Material	PBT GF		
Contact Material/Surface Finish	CuZn, silver-plated, must be ordered separately 6-pin: RBC 162 Ag, RBCB 162 Ag, 11-pin: RBC 162/1 Ag, RBCB 162/1		
Mechanical Data			
Degree of Protection [IEC 60529]	IP65, N6R EF: IP67 (only when mated with Hirschmann/Lumberg counterparts)		
Electrical Data			
Contact Resistance	≤ 10 mΩ		
Rated Voltage	6-pin + PE: 250 V AC/DC, 11-pin + PE: 60 V AC/DC	60 V AC/DC	25 V AC/50 V DC
Rated Current	6-pin + PE: 10 A, 11-pin + PE: 5 A	5 A	6-pin + PE: 10 A, 11-pin + PE: 5 A
Accessories			
Scope of Delivery or Accessories (incl.)	1 female connector, unmounted in plastic bag, with assembly instructions	1 female connector, unmounted in plastic bag, with assembly instructions	1 female connector, unmounted in plastic bag, with assembly instructions
Accessories to be Ordered Separately	RBC 162 AG, RBCB 162 AG N6R EF: NC6 encoding Order No. 831002011, contacts RBC 162 N11R EF: contacts RBC 162/1	Contacts RBC 162/1, RBCB 162/1	EMC PG screw coupling N6R-41 Order No. 734605001 EMC PG screw coupling N6R-42 Order No. 734606001 N6R: NC 6 encoding, Order No. 831002011, contacts RBC 162 N11R: contacts RBC 162, RBCB 162/1
Technical Drawing			
			



Order Information

Order No.	Order Designation	No. of Pins	Terminal Type	Conductor Size	Cable Gland	Characteristics
931720001	N6R EF	6 + PE	crimping	max. 1.5 mm ²	Ø 0.5 to 1.5 mm (PG11)	 
932630106	N11R EF	11 + PE	crimping	max. 0.5 mm ²	Ø 0.14 to 0.5 mm (PG11)	 
933101100	N11R EF F	11 + PE	crimping	max. 0.5 mm ²	Ø 0.14 to 0.5 mm (PG16)	 
933711001	N6R EF S	6 + PE	crimping	max. 1.5 mm ²	Ø 0.5 to 1.5 mm (PG13.5)	  
933700001	N11R EF S	11 + PE	crimping	max. 0.5 mm ²	Ø 0.14 to 0.5 mm (PG13.5)	  







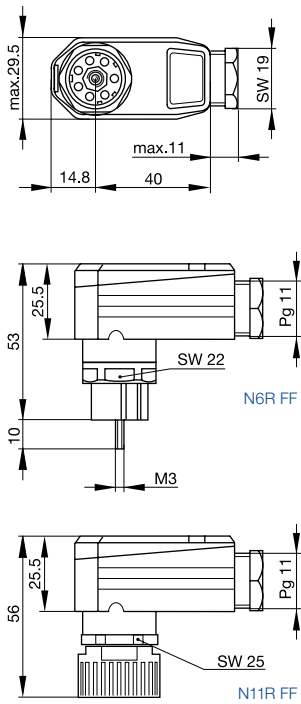
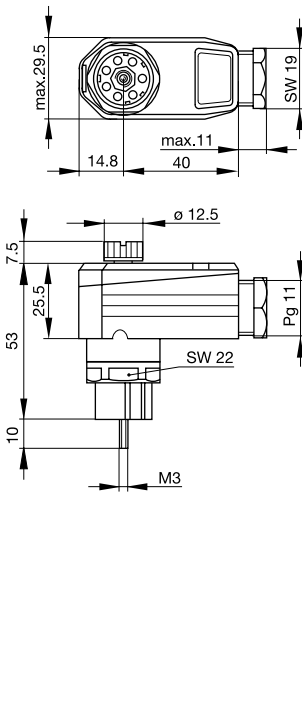
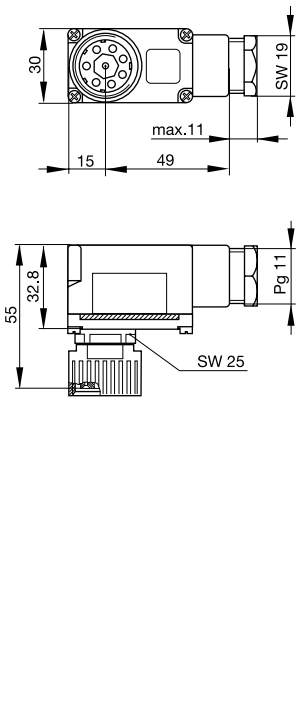

Conversion table mm² to AWG on page 20.

Circular Connectors NR Series

Technical Information

Product Description			
Order Designation	NxR FF	N6R FF R	N6R FF S 11
			
Description	Circular cable connector, female, angled, strain relief via clamping cage, spring-loaded female sockets, crimp contacts, 6 to 11-pin + PE, PG11 cable screw coupling	Circular cable connector, female, angled, strain relief via clamping cage and knurled screw, spring-loaded female sockets, crimp contacts, 6-pin + PE, PG11 cable screw coupling	Circular cable connector, female, angled, strain relief via clamping cage, transparent cover, for installation of a LED insert, spring-loaded female sockets, screw terminal contacts, 6-pin + PE, PG11 cable screw coupling
(Construction Type) Standard	DIN EN 175201-804, FF design		
Technical Data			
Ambient Temperature	-40 °C to +90 °C		
Housing Material/Grip	PBT GF		PA 6 (thread: PA 66)
Contact Holder Material	PBT GF		PA 66 GF
Contact Material/Surface Finish	CuZn, silver-plated, must be ordered separately N6R...: RBC 162 Ag, RBCB 162 Ag, N11R...: RBC 162/1 Ag, RBCB 162/1 Ag		CuZn, silver-plated
Mechanical Data			
Degree of Protection [IEC 60529]	IP65 (only when mated with Hirschmann/Lumberg counterparts)		
Electrical Data			
Contact Resistance	≤ 5 mΩ	≤ 10 mΩ	
Rated Voltage	6-pin + PE: 250 V AC/DC, 11-pin + PE: 60 V AC/DC	250 V AC/DC	
Rated Current	6-pin + PE: 10 A, 11-pin + PE: 5 A	10 A	
Accessories			
Scope of Delivery or Accessories (incl.)	1 female connector, unmounted in plastic bag, with assembly instructions	1 female connector with knurled screw, unmounted in plastic bag, with assembly instructions	1 female connector, unmounted in plastic bag, with assembly instructions
Accessories to be Ordered Separately	N6R...: NC6 encoding, Order No. 831002011, contacts RBC 162 N11R...: contacts RBC 162/1	N6R...: NC6 encoding, Order No. 831002011, contacts RBC 162	N6R...: NC6 encoding, Order No. 831002011 LED insert N6R 3 LED 24, Order No. 831411001 LED insert N6R 3 LED 24 DB, Order No. 831618001
Technical Drawing			
			



Order Information

Order No.	Order Designation	No. of Pins	Terminal Type	Conductor Size	Cable Gland	Characteristics
931435106	N6R FF	6 + PE	crimping	max. 1.5 mm ²	Ø 0.5 to 1.5 mm (PG11)	 
932632106	N11R FF	11 + PE	crimping	max. 0.5 mm ²	Ø 0.14 to 0.5 mm (PG11)	 
931553106	N6R FF R	6 + PE	crimping	max. 1.5 mm ²	Ø 0.5 to 1.5 mm (PG11)	 
932194112	N6R FF S 11	6 + PE	screw	max. 1.5 mm ²	Ø 0.5 to 1.5 mm (PG11)	 







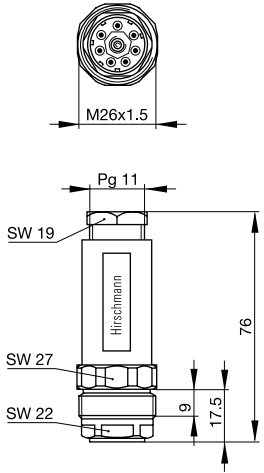
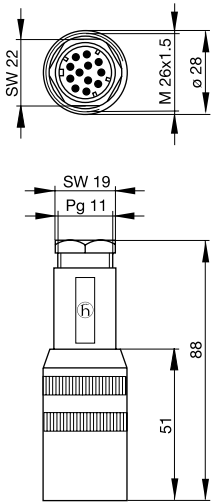
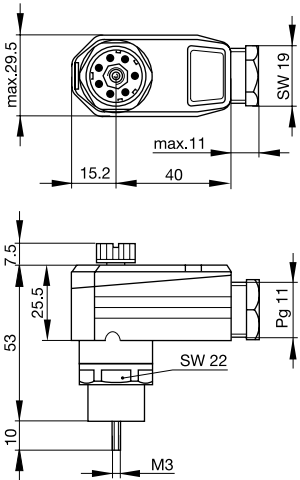



Conversion table mm² to AWG on page 20.

Circular Connectors NR Series

Technical Information

Product Description			
Order Designation	NxR DM	NxR EM	NxR FM R
			
Description	Circular cable connector, male, straight, strain relief via clamping cage, crimp pin contacts, 6 to 11-pin + PE, PG11 cable screw coupling	Circular cable connector, male, straight, strain relief via clamping cage, crimp pin contacts, 6 to 11-pin + PE, PG11 cable screw coupling	Circular cable connector, male, angled, with knurled screw, strain relief via clamping cage, crimp pin contacts, 6-pin + PE, PG11 cable screw coupling
(Construction Type) Standard	DIN EN 175201-804, DM design	DIN EN 175201-804, EM design	DIN EN 175201-804, FM design
Technical Data			
Ambient Temperature	-40 °C to +90 °C		
Housing Material/Grip	PA 6	PBT GF (thread: AlMgSi)	PBT GF
Contact Holder Material	PBT GF		
Contact Material/Surface Finish	CuZn, silver-plated, must be ordered separately 6-pin: RSC 162 Ag, RSCB 162 Ag, 11-pin: RSC 162/1 Ag, RSCB 162/1 Ag		
Mechanical Data			
Degree of Protection [IEC 60529]	IP65 (only when mated with Hirschmann/Lumberg counterparts)		
Electrical Data			
Contact Resistance	≤ 10 mΩ		
Rated Voltage	6-pin + PE: 250 V AC/DC, 11-pin + PE: 60 V AC/DC		250 V AC/DC
Rated Current	6-pin + PE: 10 A, 11-pin + PE: 5 A		10 A
Accessories			
Scope of Delivery or Accessories (incl.)	1 male connector, unmounted in plastic bag, with assembly instructions	1 male connector, unmounted in plastic bag, with assembly instructions	1 male connector with knurled screw, unmounted in plastic bag, with assembly instructions
Accessories to be Ordered Separately	Protective cap SHK 4, Order No. 734582001, contacts RSC 162	N6R...: NC6 encoding, Order No. 831002011, contacts RSC 162 N11R...: contacts RSC 162/1	N6R...: NC6 encoding, Order No. 831002011, contacts RSC 162
Technical Drawing			
			



Order Information

Order No.	Order Designation	No. of Pins	Terminal Type	Conductor Size	Cable Gland	Characteristics
932273106	N6R DM	6 + PE	crimping	max. 1.5 mm ²	Ø 0.5 to 1.5 mm (PG11)	 
932629106	N11R DM	11 + PE	crimping	max. 0.5 mm ²	Ø 0.14 to 0.5 mm (PG11)	 
931776001	N6R EM	6 + PE	crimping	max. 1.5 mm ²	Ø 0.5 to 1.5 mm (PG11)	 
932631106	N11R EM	11 + PE	crimping	max. 0.5 mm ²	Ø 0.14 to 0.5 mm (PG11)	 
931727106	N6R FM R	6 + PE	crimping	max. 1.5 mm ²	Ø 0.5 to 1.5 mm (PG11)	 





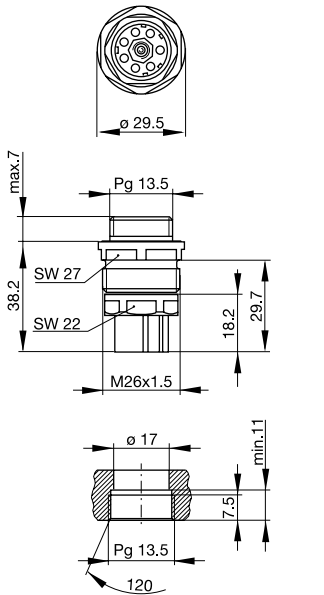
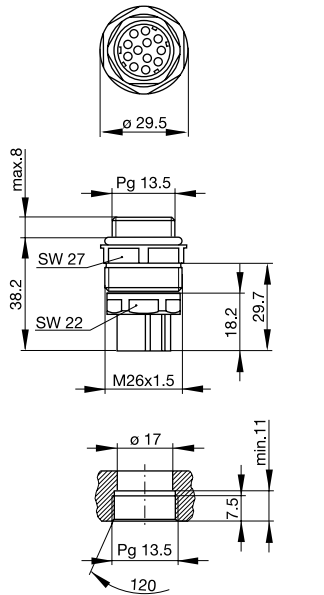
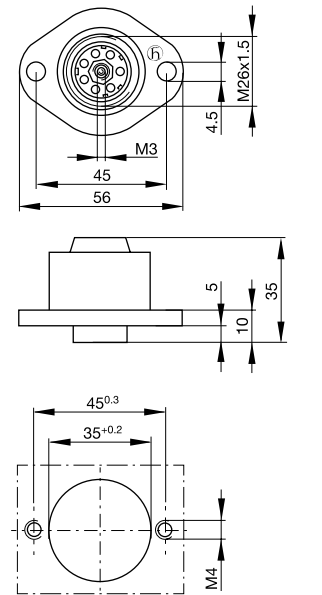

Conversion table mm² to AWG on page 20.

Circular Connectors NR Series

Technical Information

Product Description			
Order Designation	N6R AF	N11R AF 5	N6R BFE
			
Description	Female appliance connector with metal screw-on housing, contact type sprung socket, crimp contacts, 6-pin + PE	Female appliance connector with threaded metal insert in housing (metal segment), contact type sprung sockets crimp contacts, 11-pin + PE	Female appliance connector with flange, contact type sprung sockets, crimp contacts, 6-pin + PE
(Construction Type) Standard	DIN EN 175201-804, AF design		DIN EN 175201-804, BF design
Technical Data			
Ambient Temperature	-40 °C to +90 °C		
Housing Material/Grip	Screw-on housing: zinc die casting, nickel-plated PBT GF (thread: PBT GF)	PBT GF, metal segment: CuZn, nickel-plated (thread: PBT GF)	PBT GF
Contact Holder Material	PBT GF		
Contact Material/Surface Finish	CuZn, silver-plated, must be ordered separately 6-pin + PE: RSC 162 Ag, RSCB 162 Ag, 11-pin + PE: RSC 162/1 Ag, RSCB 162/1 Ag		
Mechanical Data			
Degree of Protection [IEC 60529]	IP65 (only when mated with Hirschmann/Lumberg counterparts)		
Electrical Data			
Contact Resistance	≤ 10 mΩ		
Rated Voltage	250 V AC/DC	60 V AC/DC	250 V AC/DC
Rated Current	10 A	5 A	10 A
Accessories			
Scope of Delivery or Accessories (incl.)	1 female receptacle connector, unmounted in plastic bag, with assembly instructions	1 female receptacle connector, unmounted in plastic bag, with assembly instructions	1 female receptacle connector, unmounted in plastic bag, with assembly instructions
Accessories to be Ordered Separately	N6R...: NC6 encoding, Order No. 831002011, contacts RBC 162	N11R...: contacts RBC 162/1	N6R...: NC6 encoding, Order No. 831002011, contacts RBC 162
Technical Drawing			
			



Order Information

Order No.	Order Designation	No. of Pins	Terminal Type	Conductor Size	Cable Gland	Characteristics
931855001	N6R AF	6 + PE	crimping	max. 1.5 mm ²	Ø 0.5 to 1.5 mm (PG13.5)	  
932625106	N11R AF 5	11 + PE	crimping	max. 0.5 mm ²	Ø 0.14 to 0.5 mm (PG13.5)	 
931730106	N6R BFE	6 + PE	crimping	max. 1.5 mm ²	Ø 0.5 to 1.5 mm (Flansch)	 







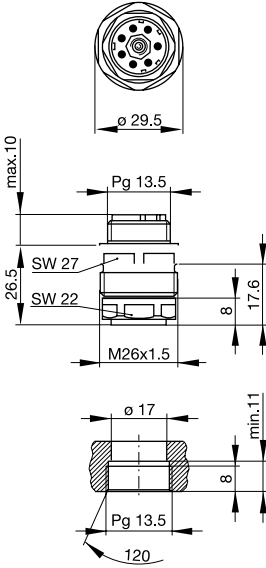
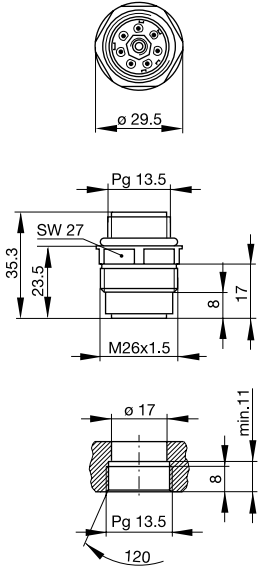
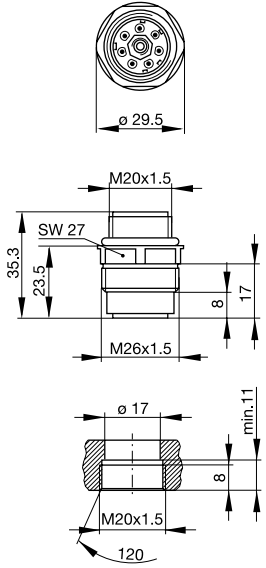









Conversion table mm² to AWG on page 20.

Circular Connectors NR Series

Technical Information

Product Description			
Order Designation	NxR AM	N6R AM X	NxR AM 2 M20
			
Description	Male appliance connector with metal screw-on housing, crimp contact pin, 6 to 11-pin + PE, PG13.5 cable screw coupling	Male appliance connector with contact holder material in housing (monoblock design), crimp contact pin, 6-pin + PE, PG11 to PG16 cable screw coupling	Male appliance connector with threaded metal insert in housing (monoblock design), crimp contact pin, 6 and 11-pin + PE
(Construction Type) Standard	DIN EN 175201-804, AM design		
Technical Data			
Ambient Temperature	-40 °C to +90 °C		
Housing Material/Grip	Zinc die casting, nickel-plated (thread: PBT GF)	PBT GF	
Contact Holder Material	PBT GF		
Contact Material/Surface Finish	CuZn, silver-plated, must be ordered separately 6-pin + PE: RSC 162 Ag, RSCB 162 Ag, 11-pin + PE: RSC 162/1 Ag, RSCB 162/1 Ag		
Mechanical Data			
Degree of Protection [IEC 60529]	IP65 (only when mated with Hirschmann/Lumberg counterparts)		
Electrical Data			
Contact Resistance	≤ 10 mΩ		
Rated Voltage	6-pin + PE: 250 V AC/DC, 11-pin + PE: 60 V AC/DC	250 V AC/DC	6-pin + PE: 250 V AC/DC, 11-pin + PE: 60 V AC/DC
Rated Current	6-pin + PE: 10 A, 11-pin + PE: 5 A	10 A	6-pin + PE: 10 A, 11-pin + PE: 5 A
Accessories			
Scope of Delivery or Accessories (incl.)	1 male receptacle connector, unmounted in plastic bag, with assembly instructions	1 male receptacle connector with seal ring in plastic bag, with assembly instructions	1 male receptacle connector with seal ring in plastic bag, with assembly instructions
Accessories to be Ordered Separately	N6R...: NC6 encoding, Order No. 831002011, Protective cap SHK 4, Order No. 734582001, contacts RSC 162 N11R...: Protective cap SHK 4, Order No. 734582001, contacts RSC 162/1	N6R...: NC6 encoding, Order No. 831002011, Protective cap SHK 4, Order No. 734582001, contacts RSC 162	N6R...: NC6 encoding Order No. 831002011, Protective cap SHK 4, Order No. 734582001, contacts RSC 162 N11R...: Protective cap SHK 4, Order No. 734582001, contacts RSC 162/1
Technical Drawing			
			



Order Information

Order No.	Order Designation	No. of Pins	Terminal Type	Conductor Size	Cable Gland	Characteristics
931434001	N6R AM	6 + PE	crimping	max. 1.5 mm ²	Ø 0.5 to 1.5 mm (PG13.5)	  
932626106	N11R AM	11 + PE	crimping	max. 0.5 mm ²	Ø 0.14 to 0.5 mm (PG13.5)	  
931592001	N6R AM 2	6 + PE	crimping	max. 1.5 mm ²	Ø 0.5 to 1.5 mm (PG13.5)	 
931592002	N6R AM 3	6 + PE	crimping	max. 1.5 mm ²	Ø 0.5 to 1.5 mm (PG11)	 
931592003	N6R AM 4	6 + PE	crimping	max. 1.5 mm ²	Ø 0.5 to 1.5 mm (PG16)	 
931592004	N6R AM 2 M20	6 + PE	crimping	max. 1.5 mm ²	Ø 0.5 to 1.5 mm (M20 x 1.5)	 
934337106	N11R AM 2 M20	11 + PE	crimping	max. 0.5 mm ²	Ø 0.14 to 0.5 mm (M20 x 1.5)	 



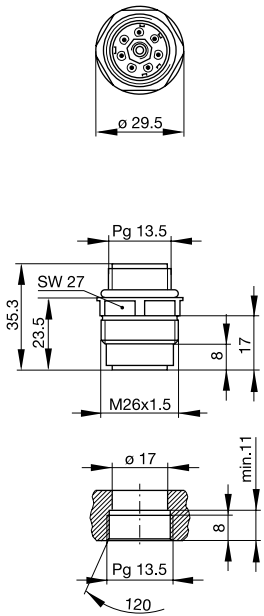
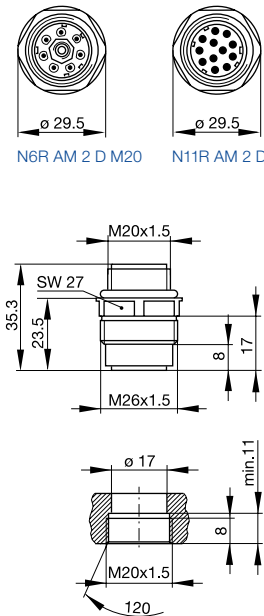
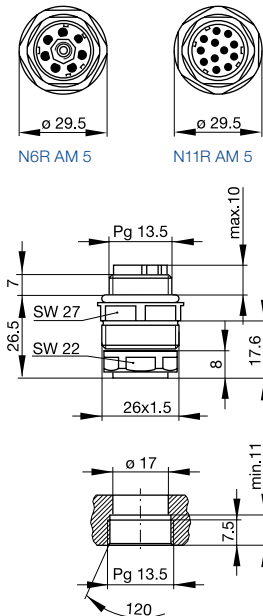

Conversion table mm² to AWG on page 20.

Circular Connectors NR Series

Technical Information

Product Description			
Order Designation	N6R AM 2 D	NxR AM 2 D M20	NxR AM 5
			
Description	Male appliance connector with fixed contacts in housing (monoblock design), pins mounted watertight, pin contact, 6-pin + PE	Male appliance connector with threaded metal insert in housing (monoblock design), pins mounted watertight, contact type pin, 6 and 11-pin + PE	Male receptacle connector with threaded metal insert in housing (metal segment), contact type pin, 6 and 11-pin + PE
(Construction Type) Standard	DIN EN 175201-804 type A		
Technical Data			
Ambient Temperature	-40 °C to +90 °C		
Housing Material/Grip	PA 66		PBT GF, metal segment: CuZn, nickel-plated (thread: PBT GF)
Contact Holder Material	PA 66		PBT GF
Contact Material/Surface Finish	CuZn, silver-plated		CuZn, silver-plated, must be ordered separately 6-pin + PE: RSC 162 Ag, RSCB 162 Ag 11-pin + PE: RSC 162/1 Ag, RSCB 162/1 Ag
Mechanical Data			
Degree of Protection [IEC 60529]	IP65, IP67 (only when mated with Hirschmann/Lumberg counterparts)		IP65 (only when mated with Hirschmann/Lumberg counterparts)
Electrical Data			
Contact Resistance	≤ 10 mΩ		
Rated Voltage	250 V AC/DC	6-pin + PE: 250 V AC/DC, 11-pin + PE: 60 V AC/DC	
Rated Current	10 A	6-pin + PE: 10 A, 11-pin + PE: 5 A	
Accessories			
Scope of Delivery or Accessories (incl.)	1 male receptacle connector with seal ring in plastic bag, with assembly instructions	1 male receptacle connector with seal ring in plastic bag, with assembly instructions	1 male receptacle connector, unmounted in plastic bag, with assembly instructions
Accessories to be Ordered Separately	N6R...: NC6 encoding, Order No. 831002011 Protective cap SHK 4, Order No. 734582001	N6R...: NC6 encoding, Order No. 831002011 Protective cap SHK 4, Order No. 734582001 N11R...: Protective cap SHK 4, Order No. 734582001	N6R...: NC6 encoding, Order No. 831002011, Protective cap SHK 4, Order No. 734582001 contacts RSC 162 N11R...: Protective cap SHK 4, Order No. 734582001 contacts RSC 162/1
Technical Drawing			
			



Order Information

Order No.	Order Designation	No. of Pins	Terminal Type	Conductor Size	Cable Gland	Characteristics
932207206	N6R AM 2 D	6 + PE	solder, hollow contacts	max. 1.5 mm ²	Ø 0.5 to 1.5 mm (PG13.5)	
932207406	N6R AM 2 D M20	6 + PE	solder, hollow contacts	max. 1.5 mm ²	Ø 0.5 to 1.5 mm (M20 x 1.5)	
934338106	N11R AM 2 D M20	11 + PE	solder, hollow contacts	max. 0.5 mm ²	Ø 0.14 to 0.5 mm (M20 x 1.5)	
931773001	N6R AM 5	6 + PE	crimping	max. 1.5 mm ²	Ø 0.5 to 1.5 mm (PG13.5)	
932627106	N11R AM 5	11 + PE	crimping	max. 0.5 mm ²	Ø 0.14 to 0.5 mm (PG13.5)	







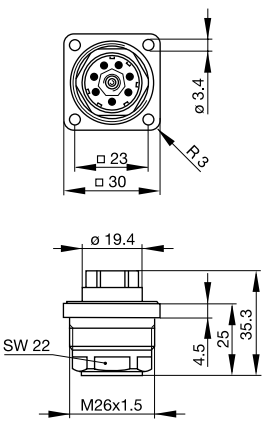
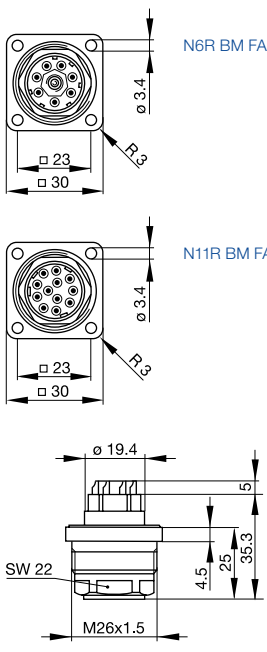
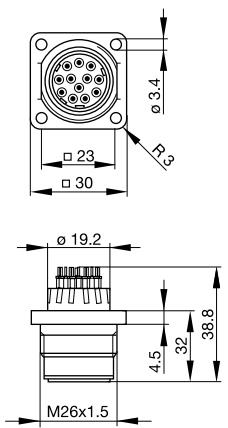







Conversion table mm² to AWG on page 20.

Circular Connectors NR Series

Technical Information

Product Description			
Order Designation	NxR BM FA	NxR BM FA S	N11R BM FA F
			
Description	Panel mounted male appliance connector with plastic flange housing, square flange, crimp pin contacts, 6 and 11-pin + PE	Panel mounted male appliance connector with metal flange housing, square flange, hollow solder contacts, 6 and 11-pin + PE	Panel mounted male appliance connector with plastic or metal flange housing, square flange, line filter 11x 1 nF, solid solder pin contacts, 11-pin + PE
(Construction Type) Standard	DIN EN 175201-804, LM design		
Technical Data			
Ambient Temperature	-40 °C to +90 °C		
Housing Material/Grip	PA 6-GF (thread: PBT GF)	Flange housing: zinc die casting, nickel-plated PBT GF (thread: PBT GF)	Plastic version: PA 66 GF Metal version: zinc die casting, nickel-plated
Contact Holder Material	PBT GF		PA 66 GF
Contact Material/Surface Finish	CuZn, silver-plated, must be ordered separately 6-pin + PE: RSC 162 Ag, RSCB 162 Ag, 11-pin + PE: RSC 162/1 Ag, RSCB 162/1 Ag	CuZn, silver-plated	
Mechanical Data			
Degree of Protection [IEC 60529]	IP65 (only when mated with Hirschmann/Lumberg counterparts)		
Electrical Data			
Contact Resistance	≤ 10 mΩ		≤ 5 mΩ
Rated Voltage	6-pin + PE: 250 V AC/DC, 11-pin + PE: 60 V AC/DC	6-pin + PE: 25 V AC/60 V DC, 11-pin + PE: 25 V AC/50 V DC	25 V AC/50 V DC
Rated Current	6-pin + PE: 10 A, 11-pin + PE: 5 A		5 A
Accessories			
Scope of Delivery or Accessories (incl.)	1 surface mounted male connector with flat seal, unmounted in plastic bag, with assembly instructions	1 surface mounted male connector, unmounted in plastic bag, with assembly instructions	50 surface mounted male connectors on styrofoam pallet
Accessories to be Ordered Separately	N6R...: NC6 encoding, Order No. 831002011, Protective cap SHK 4, Order No. 734582001 contacts RSC 162 N11R...: Protective cap SHK 4, Order No. 734582001 contacts RSC 162/1	N6R...: NC6 encoding, Order No. 831002011, Flat seal N6R-40, Order No. 734633001 Protective cap SHK 4, Order No. 734582001 N11R...: Flat seal N6R-40, Order No. 734633001 Protective cap SHK 4, Order No. 734582001	Flat seal N6R-40, Order No. 734633001 Protective cap SHK 4, Order No. 734582001
Technical Drawing			
			

Order Information

Order No.	Order Designation	No. of Pins	Terminal Type	Conductor Size	Cable Gland	Characteristics
932437206	N6R BM FA	6 + PE	crimping	max. 1.5 mm ²	Ø 0.5 to 1.5 mm (Flange)	 
932628206	N11R BM FA	11 + PE	crimping	max. 0.5 mm ²	Ø 0.14 to 0.5 mm (Flange)	 
933710001	N6R BM FA S	6 + PE	solder, hollow contacts	max. 1.5 mm ²	Ø 0.5 to 1.5 mm (Flange)	  
933699001	N11R BM FA S	11 + PE	solder, hollow contacts	max. 0.5 mm ²	Ø 0.14 to 0.5 mm (Flange)	  
933100100	N11R BM FA F plastic	11 + PE	solder, solid pins	max. 0.5 mm ²	Ø 0.14 to 0.5 mm (Flange)	 
934392001	N11R BM FA F metal	11 + PE	solder, solid pins	max. 0.5 mm ²	Ø 0.14 to 0.5 mm (Flange)	  

Conversion table mm² to AWG on page 20.

