

## SN74AHC1G08 Single 2-Input Positive-AND Gate

### 1 Features

- Operating Range 2 V to 5.5 V
- Maximum  $t_{pd}$  of 7 ns at 5 V
- Low Power Consumption, 10- $\mu$ A Maximum  $I_{CC}$
- $\pm$ 8-mA Output Drive at 5 V
- Schmitt-Trigger Action at All Inputs Makes the Circuit Tolerant for Slower Input Rise and Fall Time
- Latch-Up Performance Exceeds 250 mA Per JESD 17
- ESD Protection Exceeds JESD 22
  - 2000-V Human Body Model (A114-A)
  - 200-V Machine Model (A115-A)
  - 1000-V Charged-Device Model (C101)

### 2 Applications

- Barcode Scanners
- Cable Solutions
- E-Books
- Embedded PCs
- Field Transmitter: Temperature or Pressure Sensors
- Fingerprint Biometrics
- HVAC: Heating, Ventilating, and Air Conditioning
- Network-Attached Storage (NAS)
- Server Motherboard and PSU
- Software Defined Radios (SDR)
- TV: High Definition (HDTV), LCD, and Digital
- Video Communications Systems
- Wireless Data Access Cards, Headsets, Keyboards, Mice, and LAN Cards

### 3 Description

The SN74AHC1G08 device is a single 2-input positive-AND gate. The device performs the Boolean function  $Y = A \bullet B$  or  $Y = A + B$  in positive logic.

#### Device Information<sup>(1)</sup>

PART NUMBER	PACKAGE	BODY SIZE (NOM)
SN74AHC1G08DBV	SOT-23 (5)	2.90 mm x 1.60 mm
SN74AHC1G08DCK	SC70 (5)	2.00 mm x 1.25 mm
SN74AHC1G08DRL	SOT (5)	1.60 mm x 1.20 mm

(1) For all available packages, see the orderable addendum at the end of the data sheet.

#### Logic Diagram (Positive Logic)



## Table of Contents

<b>1 Features</b> ..... 1 <b>2 Applications</b> ..... 1 <b>3 Description</b> ..... 1 <b>4 Revision History</b> ..... 2 <b>5 Pin Configuration and Functions</b> ..... 3 <b>6 Specifications</b> ..... 4 6.1 Absolute Maximum Ratings ..... 4 6.2 ESD Ratings ..... 4 6.3 Recommended Operating Conditions ..... 4 6.4 Thermal Information ..... 5 6.5 Electrical Characteristics ..... 5 6.6 Switching Characteristics, $V_{CC} = 3.3\text{ V} \pm 0.3\text{ V}$ ..... 5 6.7 Switching Characteristics, $V_{CC} = 5\text{ V} \pm 0.5\text{ V}$ ..... 5 6.8 Operating Characteristics ..... 6 6.9 Typical Characteristics ..... 6 <b>7 Parameter Measurement Information</b> ..... 7 <b>8 Detailed Description</b> ..... 8 8.1 Overview ..... 8	8.2 Functional Block Diagram ..... 8 8.3 Feature Description ..... 8 8.4 Device Functional Modes ..... 8 <b>9 Application and Implementation</b> ..... 9 9.1 Application Information ..... 9 9.2 Typical Application ..... 9 <b>10 Power Supply Recommendations</b> ..... 10 <b>11 Layout</b> ..... 10 11.1 Layout Guidelines ..... 10 11.2 Layout Example ..... 11 <b>12 Device and Documentation Support</b> ..... 11 12.1 Documentation Support ..... 11 12.2 Community Resources ..... 11 12.3 Trademarks ..... 11 12.4 Electrostatic Discharge Caution ..... 11 12.5 Glossary ..... 11 <b>13 Mechanical, Packaging, and Orderable Information</b> ..... 12
---	---

## 4 Revision History

NOTE: Page numbers for previous revisions may differ from page numbers in the current version.

Changes from Revision O (June 2015) to Revision P	Page
• Changed $V_{IL}$ max value on <i>Recommended Operating Conditions</i> table from 5.5 V to 0.5 V .....	4

Changes from Revision N (November 2012) to Revision O	Page
• Removed <i>Ordering Information</i> table. ....	1
• Added <i>Applications</i> .....	1
• Added <i>Device Information table</i> . ....	1
• Added <i>ESD Ratings</i> table. ....	4
• Added <i>Thermal Information table</i> . ....	5

Changes from Revision M (June 2005) to Revision N	Page
• Changed document format from Quicksilver to DocZone. ....	1

## 5 Pin Configuration and Functions

**DBV Package**  
**5-Pin SOT-23**  
**Top View**

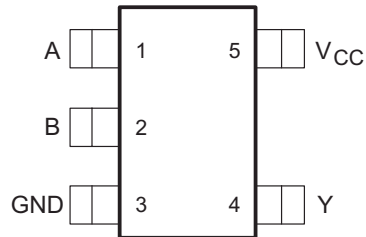

**DCK Package**  
**5-Pin SC70**  
**Top View**

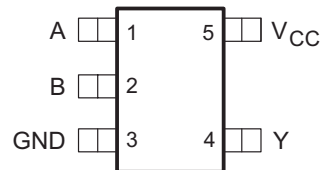

**DRL Package**  
**5-Pin SOT**  
**Top View**

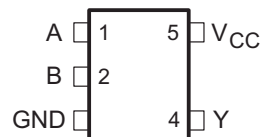

See mechanical drawings for dimensions (in [Mechanical, Packaging, and Orderable Information](#)).

### Pin Functions

PIN		I/O	DESCRIPTION
NO.	NAME		
1	A	I	Data Input
2	B	I	Data Input
3	GND	—	Ground
4	Y	O	Data Output
5	VCC	—	Power

## 6 Specifications

### 6.1 Absolute Maximum Ratings

 over operating free-air temperature range (unless otherwise noted)<sup>(1)</sup>

		MIN	MAX	UNIT
$V_{CC}$	Supply voltage	-0.5	7	V
$V_I$	Input voltage <sup>(2)</sup>	-0.5	7	V
$V_O$	Output voltage <sup>(2)</sup>	-0.5	$V_{CC} + 0.5$	V
$I_{IK}$	Input clamp current	$V_I < 0$	-20	mA
$I_{OK}$	Output clamp current	$V_O < 0$ or $V_O > V_{CC}$	$\pm 20$	mA
$I_O$	Continuous output current	$V_O = 0$ to $V_{CC}$	$\pm 25$	mA
	Continuous current through $V_{CC}$ or GND		$\pm 50$	mA
$T_J$	Junction temperature		150	°C
$T_{stg}$	Storage temperature	-65	150	°C

- (1) Stresses beyond those listed under *Absolute Maximum Ratings* may cause permanent damage to the device. These are stress ratings only, and functional operation of the device at these or any other conditions beyond those indicated under *Recommended Operating Conditions* is not implied. Exposure to absolute-maximum-rated conditions for extended periods may affect device reliability.
- (2) The input and output voltage ratings may be exceeded if the input and output current ratings are observed.

### 6.2 ESD Ratings

		VALUE	UNIT
$V_{(ESD)}$	Electrostatic discharge	Human body model (HBM), per ANSI/ESDA/JEDEC JS-001, all pins <sup>(1)</sup>	2000
		Charged-device model (CDM), per JEDEC specification JESD22-C101, all pins <sup>(2)</sup>	1000

- (1) JEDEC document JEP155 states that 500-V HBM allows safe manufacturing with a standard ESD control process.
- (2) JEDEC document JEP157 states that 250-V CDM allows safe manufacturing with a standard ESD control process.

### 6.3 Recommended Operating Conditions

 over operating free-air temperature range (unless otherwise noted)<sup>(1)</sup>

		MIN	MAX	UNIT
$V_{CC}$	Supply voltage	2	5.5	V
$V_{IH}$	High-level input voltage	$V_{CC} = 2\text{ V}$	1.5	V
		$V_{CC} = 3\text{ V}$	2.1	
		$V_{CC} = 5.5\text{ V}$	3.85	
$V_{IL}$	Low-level Input voltage	$V_{CC} = 2\text{ V}$	0.5	V
		$V_{CC} = 3\text{ V}$	0.9	
		$V_{CC} = 5.5\text{ V}$	1.65	
$V_I$	Input voltage	0	5.5	V
$V_O$	Output voltage	0	$V_{CC}$	V
$I_{OH}$	High-level output current	$V_{CC} = 2\text{ V}$	-50	$\mu\text{A}$
		$V_{CC} = 3.3\text{ V} \pm 0.3\text{ V}$	-4	mA
		$V_{CC} = 5\text{ V} \pm 0.5\text{ V}$	-8	
$I_{OL}$	Low-level output current	$V_{CC} = 2\text{ V}$	50	$\mu\text{A}$
		$V_{CC} = 3.3\text{ V} \pm 0.3\text{ V}$	4	mA
		$V_{CC} = 5\text{ V} \pm 0.5\text{ V}$	8	
$\Delta t/\Delta v$	Input transition rise or fall rate	$V_{CC} = 3.3\text{ V} \pm 0.3\text{ V}$	100	ns/V
		$V_{CC} = 5\text{ V} \pm 0.5\text{ V}$	20	
$T_A$	Operating free-air temperature	-55	125	°C

- (1) All unused inputs of the device must be held at  $V_{CC}$  or GND to ensure proper device operation. Refer to the TI application report, *Implications of Slow or Floating CMOS Inputs*, SCBA004.

## 6.4 Thermal Information

THERMAL METRIC <sup>(1)</sup>	SN74AHC1G08			UNIT
	DBV (SOT-23)	DCK (SC70)	DRL (SOT)	
	5 PINS	5 PINS	5 PINS	
R <sub>θJA</sub> Junction-to-ambient thermal resistance	206	252	142	°C/W

(1) For more information about traditional and new thermal metrics, see the *Semiconductor and IC Package Thermal Metrics* application report, [SPRA953](#).

## 6.5 Electrical Characteristics

over operating free-air temperature range (unless otherwise noted)

PARAMETER	TEST CONDITIONS	V <sub>CC</sub>	T <sub>A</sub> = 25°C			T <sub>A</sub> = -55°C to 125°C		UNIT
			MIN	TYP	MAX	MIN	MAX	
V <sub>OH</sub>	I <sub>OH</sub> = -50 μA	2 V	1.9	2		1.9	V	
		3 V	2.9	3		2.9		
		4.5 V	4.4	4.5		4.4		
	I <sub>OH</sub> = -4 mA	3 V	2.58		2.48			
	I <sub>OH</sub> = -8 mA	4.5 V	3.94		3.8			
V <sub>OL</sub>	I <sub>OL</sub> = 50 μA	2 V			0.1	0.1	V	
		3 V			0.1	0.1		
		4.5 V			0.1	0.1		
	I <sub>OL</sub> = 4 mA	3 V		0.36	0.44			
	I <sub>OL</sub> = 8 mA	4.5 V		0.36	0.44			
I <sub>I</sub>	V <sub>I</sub> = 5.5 V or GND	0 V to 5.5 V			±0.1	±1	μA	
I <sub>CC</sub>	V <sub>I</sub> = V <sub>CC</sub> or GND, I <sub>O</sub> = 0	5.5 V			1	10	μA	
C <sub>i</sub>	V <sub>I</sub> = V <sub>CC</sub> or GND	5 V		4	10	10	pF	

## 6.6 Switching Characteristics, V<sub>CC</sub> = 3.3 V ± 0.3 V

over recommended operating free-air temperature range, V<sub>CC</sub> = 3.3 V ± 0.3 V (unless otherwise noted) (see [Figure 2](#))

PARAMETER	FROM (INPUT)	TO (OUTPUT)	OUTPUT CAPACITANCE	T <sub>A</sub> = 25°C			T <sub>A</sub> = -40°C to 85°C		T <sub>A</sub> = -55°C to 125°C		UNIT
				MIN	TYP	MAX	MIN	MAX	MIN	MAX	
t <sub>PLH</sub>	A or B	Y	C <sub>L</sub> = 15 pF	6.2	8.8		1	10.5	1	11	ns
t <sub>PHL</sub>				6.2	8.8		1	10.5	1	11	
t <sub>PLH</sub>	A or B	Y	C <sub>L</sub> = 50 pF	8.7	12.3		1	14	1	14.5	ns
t <sub>PHL</sub>				8.7	12.3		1	14	1	14.5	

## 6.7 Switching Characteristics, V<sub>CC</sub> = 5 V ± 0.5 V

over recommended operating free-air temperature range, V<sub>CC</sub> = 5 V ± 0.5 V (unless otherwise noted) (see [Figure 2](#))

PARAMETER	FROM (INPUT)	TO (OUTPUT)	OUTPUT CAPACITANCE	T <sub>A</sub> = 25°C			T <sub>A</sub> = -40°C to 85°C		T <sub>A</sub> = -55°C to 125°C		UNIT
				MIN	TYP	MAX	MIN	MAX	MIN	MAX	
t <sub>PLH</sub>	A or B	Y	C <sub>L</sub> = 15 pF	4.3	5.9		1	7	1	7.5	ns
t <sub>PHL</sub>				4.3	5.9		1	7	1	7.5	
t <sub>PLH</sub>	A or B	Y	C <sub>L</sub> = 50 pF	5.8	7.9		1	9	1	9.5	ns
t <sub>PHL</sub>				5.8	7.9		1	9	1	9.5	

## 6.8 Operating Characteristics

 $V_{CC} = 5\text{ V}$ ,  $T_A = 25^\circ\text{C}$ 

PARAMETER	TEST CONDITIONS	TYP	UNIT
$C_{pd}$ Power dissipation capacitance	No load, $f = 1\text{ MHz}$	18	pF

## 6.9 Typical Characteristics

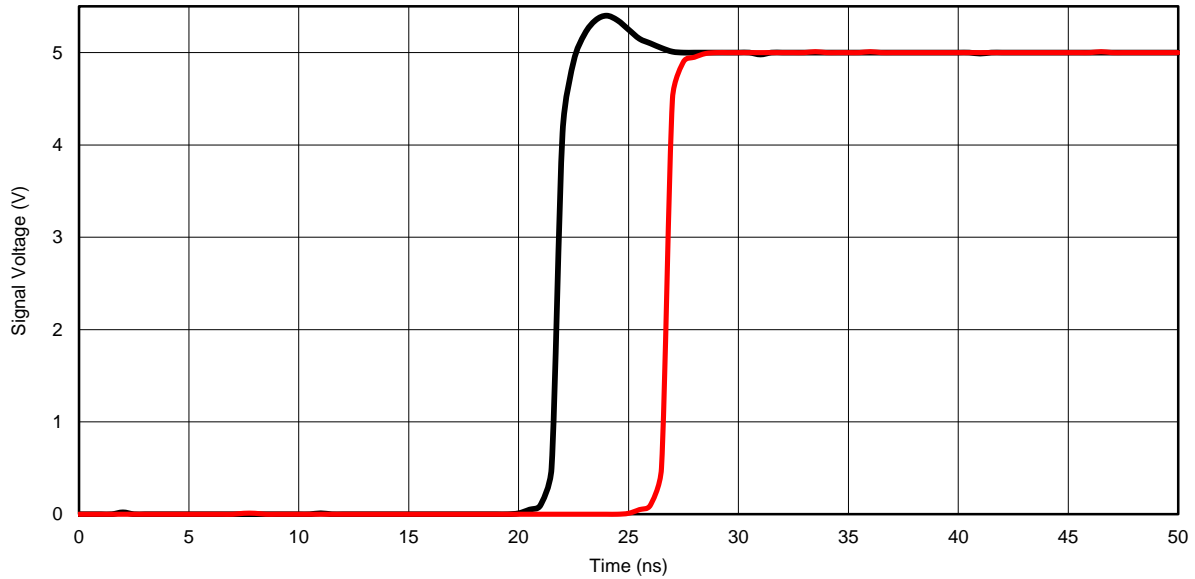
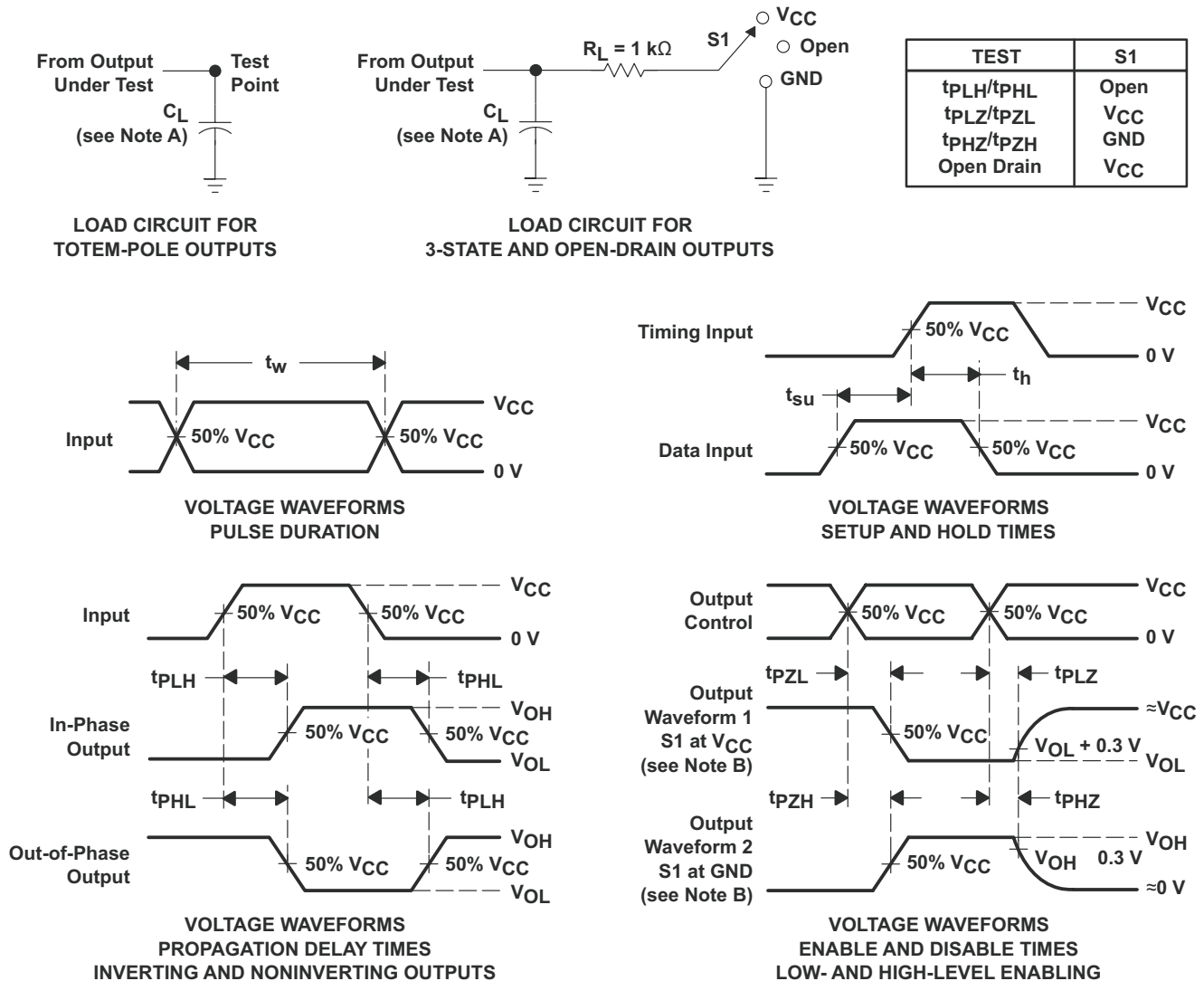

Figure 1. Response Time vs Output Voltage ( $T_A = 25^\circ\text{C}$ ,  $V_A = 5\text{ V}$ )

## 7 Parameter Measurement Information



- A.  $C_L$  includes probe and jig capacitance.
- B. Waveform 1 is for an output with internal conditions such that the output is low except when disabled by the output control.  
Waveform 2 is for an output with internal conditions such that the output is high except when disabled by the output control.
- C. All input pulses are supplied by generators having the following characteristics:  $PRR \leq 1\text{ MHz}$ ,  $Z_O = 50\ \Omega$ ,  $t_r \leq 3\text{ ns}$ ,  $t_f \leq 3\text{ ns}$ .
- D. The outputs are measured one at a time with one input transition per measurement.
- E. All parameters and waveforms are not applicable to all devices.

Figure 2. Load Circuit and Voltage Waveforms

## 8 Detailed Description

### 8.1 Overview

The SN74AHC1G08 device is a single 2-input positive-AND gate. The device performs the Boolean function  $Y = A \bullet B$  or  $Y = A + B$  in positive logic.

### 8.2 Functional Block Diagram

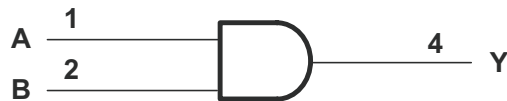

**Figure 3. Logic Diagram (Positive Side)**

### 8.3 Feature Description

The SN74AHC1G08 device has a wide operating  $V_{CC}$  range of 2 V to 5.5 V, which allows it to be used in a broad range of systems. The low propagation delay allows fast switching and higher operation speeds. In addition, the low-power consumption makes this device a good choice for portable and battery power-sensitive applications.

### 8.4 Device Functional Modes

[Table 1](#) lists the functional modes for SN74AHC1G08.

**Table 1. Function Table**

INPUTS		OUTPUT Y
A	B	
H	H	H
L	X	L
X	L	L

## 9 Application and Implementation

### NOTE

Information in the following applications sections is not part of the TI component specification, and TI does not warrant its accuracy or completeness. TI's customers are responsible for determining suitability of components for their purposes. Customers should validate and test their design implementation to confirm system functionality.

### 9.1 Application Information

A common application for AND gates is their use in power sequencing. Power sequencing is often employed in applications that require a processor or other delicate device with specific voltage timing requirements in order to protect the device from malfunctioning. Using the SN74AHC1G08 to verify that the processor has turned on can protect it from any harmful signals.

### 9.2 Typical Application

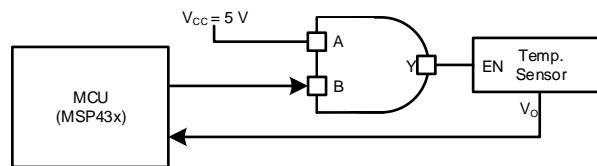

Figure 4. Power Sequencing Application

#### 9.2.1 Design Requirements

The SN74AHC1G08 device uses CMOS technology and has balanced output drive. Take care to avoid bus contention because it can drive currents that would exceed maximum limits.

The SN74AHC1G08 allows switching control of analog and digital signals with a digital control signal. All input signals should remain as close to either 0 V or  $V_{CC}$  as possible for optimal operation.

#### 9.2.2 Detailed Design Procedure

1. Recommended input conditions:
  - For rise time and fall time specifications, see  $\Delta t/\Delta v$  in the [Recommended Operating Conditions](#) table.
  - For specified high and low levels, see  $V_{IH}$  and  $V_{IL}$  in the [Recommended Operating Conditions](#) table.
  - Inputs and outputs are overvoltage tolerant and can therefore go as high as 5.5 V at any valid  $V_{CC}$ .
2. Recommended output conditions:
  - Load currents should not exceed  $\pm 50$  mA.
3. Frequency selection criterion:
  - The effects of frequency upon the device's power consumption should be studied in *CMOS Power Consumption and CPD Calculation*, [SCAA035](#).
  - Added trace resistance and capacitance can reduce maximum frequency capability; follow the layout practices listed in the [Layout](#) section.

## Typical Application (continued)

### 9.2.3 Application Curves

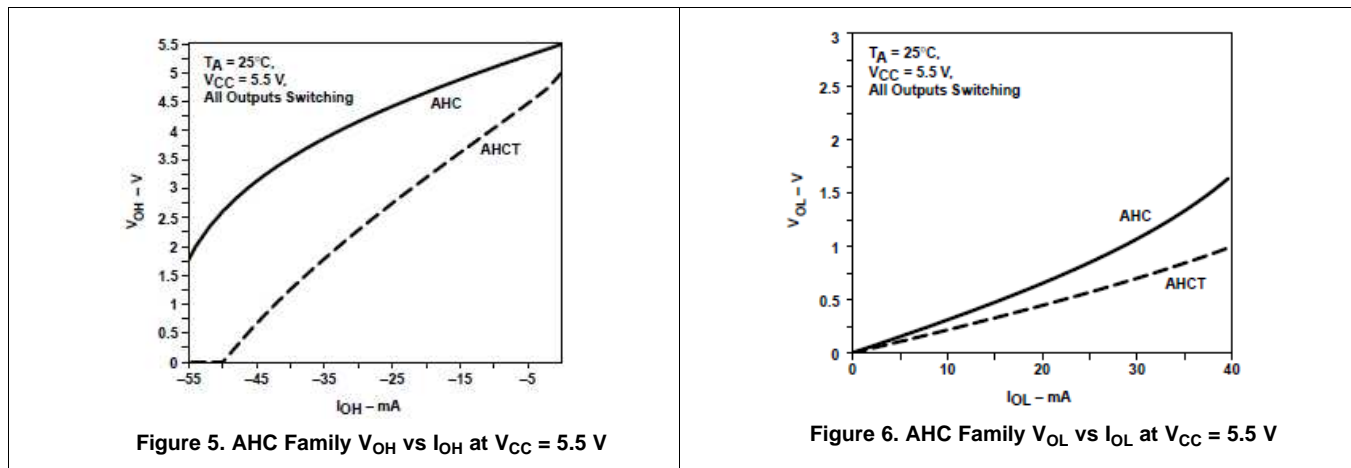

## 10 Power Supply Recommendations

The power supply can be any voltage between the minimum and maximum supply voltage rating listed in the [Recommended Operating Conditions](#) table.

Each  $V_{CC}$  terminal should have a bypass capacitor to prevent power disturbance. A 0.1- $\mu$ F bypass capacitor is recommended for devices with a single supply. If multiple pins are labeled  $V_{CC}$ , then a 0.01- $\mu$ F or 0.022- $\mu$ F capacitor is recommended for each  $V_{CC}$  because the  $V_{CC}$  pins are tied together internally. For devices with dual-supply pins operating at different voltages, for example  $V_{CC}$  and  $V_{DD}$ , a 0.1- $\mu$ F bypass capacitor is recommended for each supply pin. Use multiple bypass capacitors in parallel to reject different frequencies of noise. Capacitors with values of 0.1  $\mu$ F and 1  $\mu$ F are commonly used in parallel. The bypass capacitor should be installed as close to the power terminal as possible for best results.

## 11 Layout

### 11.1 Layout Guidelines

Reflections and matching are closely related to the loop antenna theory but are different enough to be discussed separately from the theory. When a PCB trace turns a corner at a 90° angle, a reflection can occur. A reflection occurs primarily because of the change of width of the trace. At the apex of the turn, the trace width increases to 1.414 times the width. This increase upsets the transmission-line characteristics, especially the distributed capacitance and self-inductance of the trace which results in the reflection. Not all PCB traces can be straight and therefore some traces must turn corners. [Figure 7](#) shows progressively better techniques of rounding corners. Only the last example (BEST) maintains constant trace width and minimizes reflections.

## 11.2 Layout Example

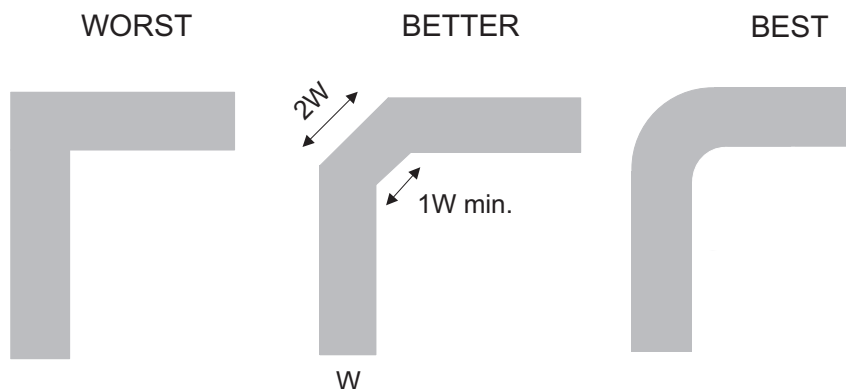

Figure 7. Trace Example

## 12 Device and Documentation Support

### 12.1 Documentation Support

#### 12.1.1 Related Documentation

For related documentation see the following:

- *Implications of Slow or Floating CMOS Inputs*, [SCBA004](#)
- *CMOS Power Consumption and CPD Calculation*, [SCAA035](#)
- *Selecting the Right Texas Instruments Signal Switch*, [SZZA030](#)

### 12.2 Community Resources

The following links connect to TI community resources. Linked contents are provided "AS IS" by the respective contributors. They do not constitute TI specifications and do not necessarily reflect TI's views; see TI's [Terms of Use](#).

**TI E2E™ Online Community** *TI's Engineer-to-Engineer (E2E) Community*. Created to foster collaboration among engineers. At [e2e.ti.com](http://e2e.ti.com), you can ask questions, share knowledge, explore ideas and help solve problems with fellow engineers.

**Design Support** *TI's Design Support* Quickly find helpful E2E forums along with design support tools and contact information for technical support.

### 12.3 Trademarks

E2E is a trademark of Texas Instruments.

All other trademarks are the property of their respective owners.

### 12.4 Electrostatic Discharge Caution



These devices have limited built-in ESD protection. The leads should be shorted together or the device placed in conductive foam during storage or handling to prevent electrostatic damage to the MOS gates.

### 12.5 Glossary

[SLYZ022](#) — *TI Glossary*.

This glossary lists and explains terms, acronyms, and definitions.

### 13 Mechanical, Packaging, and Orderable Information

The following pages include mechanical, packaging, and orderable information. This information is the most current data available for the designated devices. This data is subject to change without notice and revision of this document. For browser based versions of this data sheet, refer to the left hand navigation.

**PACKAGING INFORMATION**

Orderable Device	Status (1)	Package Type	Package Drawing	Pins	Package Qty	Eco Plan (2)	Lead/Ball Finish (6)	MSL Peak Temp (3)	Op Temp (°C)	Device Marking (4/5)	Samples
SN74AHC1G08DBV3	ACTIVE	SOT-23	DBV	5	3000	Pb-Free (RoHS)	CU SNBI	Level-1-260C-UNLIM	-55 to 125	A08Y	<a href="#">Samples</a>
SN74AHC1G08DBVR	ACTIVE	SOT-23	DBV	5	3000	Green (RoHS & no Sb/Br)	CU NIPDAU   CU SN	Level-1-260C-UNLIM	-55 to 125	(A083, A08G, A08J, A08L, A08S)	<a href="#">Samples</a>
SN74AHC1G08DBVRE4	ACTIVE	SOT-23	DBV	5	3000	Green (RoHS & no Sb/Br)	CU NIPDAU	Level-1-260C-UNLIM	-55 to 125	A08G	<a href="#">Samples</a>
SN74AHC1G08DBVRG4	ACTIVE	SOT-23	DBV	5	3000	Green (RoHS & no Sb/Br)	CU NIPDAU	Level-1-260C-UNLIM	-55 to 125	A08G	<a href="#">Samples</a>
SN74AHC1G08DBVT	ACTIVE	SOT-23	DBV	5	250	Green (RoHS & no Sb/Br)	CU NIPDAU   CU SN	Level-1-260C-UNLIM	-55 to 125	(A083, A08G, A08J, A08L, A08S)	<a href="#">Samples</a>
SN74AHC1G08DBVTG4	ACTIVE	SOT-23	DBV	5	250	Green (RoHS & no Sb/Br)	CU NIPDAU	Level-1-260C-UNLIM	-55 to 125	A08G	<a href="#">Samples</a>
SN74AHC1G08DCK3	ACTIVE	SC70	DCK	5	3000	Pb-Free (RoHS)	CU SNBI	Level-1-260C-UNLIM	-55 to 125	AEY	<a href="#">Samples</a>
SN74AHC1G08DCKR	ACTIVE	SC70	DCK	5	3000	Green (RoHS & no Sb/Br)	CU NIPDAU   CU SN	Level-1-260C-UNLIM	-55 to 125	(AE3, AEG, AEJ, AE L, AES)	<a href="#">Samples</a>
SN74AHC1G08DCKRE4	ACTIVE	SC70	DCK	5	3000	Green (RoHS & no Sb/Br)	CU NIPDAU	Level-1-260C-UNLIM	-55 to 125	AE3	<a href="#">Samples</a>
SN74AHC1G08DCKRG4	ACTIVE	SC70	DCK	5	3000	Green (RoHS & no Sb/Br)	CU NIPDAU	Level-1-260C-UNLIM	-55 to 125	AE3	<a href="#">Samples</a>
SN74AHC1G08DCKT	ACTIVE	SC70	DCK	5	250	Green (RoHS & no Sb/Br)	CU NIPDAU   CU SN	Level-1-260C-UNLIM	-55 to 125	(AE3, AEG, AEJ, AE L, AES)	<a href="#">Samples</a>
SN74AHC1G08DCKTE4	ACTIVE	SC70	DCK	5	250	Green (RoHS & no Sb/Br)	CU NIPDAU	Level-1-260C-UNLIM	-55 to 125	AE3	<a href="#">Samples</a>
SN74AHC1G08DCKTG4	ACTIVE	SC70	DCK	5	250	Green (RoHS & no Sb/Br)	CU NIPDAU	Level-1-260C-UNLIM	-55 to 125	AE3	<a href="#">Samples</a>
SN74AHC1G08DRLR	ACTIVE	SOT-5X3	DRL	5	4000	Green (RoHS & no Sb/Br)	CU NIPDAU   CU NIPDAUAG	Level-1-260C-UNLIM	-55 to 125	(AEB, AES)	<a href="#">Samples</a>
SN74AHC1G08DRLRG4	ACTIVE	SOT-5X3	DRL	5	4000	Green (RoHS & no Sb/Br)	CU NIPDAU	Level-1-260C-UNLIM	-55 to 125	(AEB, AES)	<a href="#">Samples</a>

(1) The marketing status values are defined as follows:

**ACTIVE:** Product device recommended for new designs.

**LIFEBUY:** TI has announced that the device will be discontinued, and a lifetime-buy period is in effect.

**NRND:** Not recommended for new designs. Device is in production to support existing customers, but TI does not recommend using this part in a new design.

---

**PREVIEW:** Device has been announced but is not in production. Samples may or may not be available.

**OBSELETE:** TI has discontinued the production of the device.

<sup>(2)</sup> **RoHS:** TI defines "RoHS" to mean semiconductor products that are compliant with the current EU RoHS requirements for all 10 RoHS substances, including the requirement that RoHS substance do not exceed 0.1% by weight in homogeneous materials. Where designed to be soldered at high temperatures, "RoHS" products are suitable for use in specified lead-free processes. TI may reference these types of products as "Pb-Free".

**RoHS Exempt:** TI defines "RoHS Exempt" to mean products that contain lead but are compliant with EU RoHS pursuant to a specific EU RoHS exemption.

**Green:** TI defines "Green" to mean the content of Chlorine (Cl) and Bromine (Br) based flame retardants meet JS709B low halogen requirements of <=1000ppm threshold. Antimony trioxide based flame retardants must also meet the <=1000ppm threshold requirement.

<sup>(3)</sup> MSL, Peak Temp. - The Moisture Sensitivity Level rating according to the JEDEC industry standard classifications, and peak solder temperature.

<sup>(4)</sup> There may be additional marking, which relates to the logo, the lot trace code information, or the environmental category on the device.

<sup>(5)</sup> Multiple Device Markings will be inside parentheses. Only one Device Marking contained in parentheses and separated by a "~" will appear on a device. If a line is indented then it is a continuation of the previous line and the two combined represent the entire Device Marking for that device.

<sup>(6)</sup> Lead/Ball Finish - Orderable Devices may have multiple material finish options. Finish options are separated by a vertical ruled line. Lead/Ball Finish values may wrap to two lines if the finish value exceeds the maximum column width.

**Important Information and Disclaimer:**The information provided on this page represents TI's knowledge and belief as of the date that it is provided. TI bases its knowledge and belief on information provided by third parties, and makes no representation or warranty as to the accuracy of such information. Efforts are underway to better integrate information from third parties. TI has taken and continues to take reasonable steps to provide representative and accurate information but may not have conducted destructive testing or chemical analysis on incoming materials and chemicals. TI and TI suppliers consider certain information to be proprietary, and thus CAS numbers and other limited information may not be available for release.

In no event shall TI's liability arising out of such information exceed the total purchase price of the TI part(s) at issue in this document sold by TI to Customer on an annual basis.

**OTHER QUALIFIED VERSIONS OF SN74AHC1G08 :**

- Automotive: [SN74AHC1G08-Q1](#)

NOTE: Qualified Version Definitions:

- Automotive - Q100 devices qualified for high-reliability automotive applications targeting zero defects

## TAPE AND REEL INFORMATION

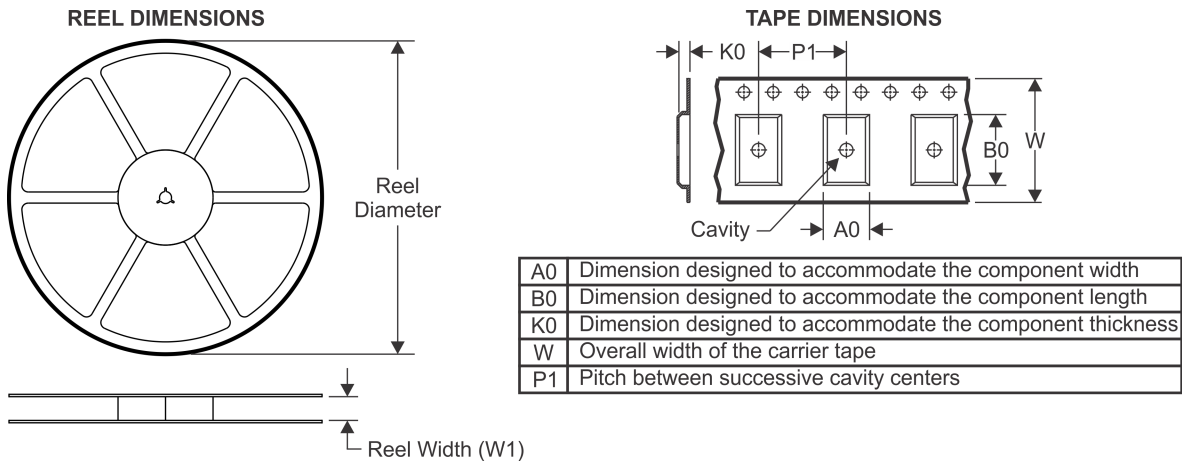

### QUADRANT ASSIGNMENTS FOR PIN 1 ORIENTATION IN TAPE



\*All dimensions are nominal

Device	Package Type	Package Drawing	Pins	SPQ	Reel Diameter (mm)	Reel Width W1 (mm)	A0 (mm)	B0 (mm)	K0 (mm)	P1 (mm)	W (mm)	Pin1 Quadrant
SN74AHC1G08DBVR	SOT-23	DBV	5	3000	178.0	9.0	3.3	3.2	1.4	4.0	8.0	Q3
SN74AHC1G08DBVR	SOT-23	DBV	5	3000	178.0	9.2	3.3	3.23	1.55	4.0	8.0	Q3
SN74AHC1G08DBVRG4	SOT-23	DBV	5	3000	178.0	9.0	3.23	3.17	1.37	4.0	8.0	Q3
SN74AHC1G08DBVT	SOT-23	DBV	5	250	178.0	9.0	3.3	3.2	1.4	4.0	8.0	Q3
SN74AHC1G08DBVT	SOT-23	DBV	5	250	180.0	8.4	3.23	3.17	1.37	4.0	8.0	Q3
SN74AHC1G08DBVT	SOT-23	DBV	5	250	178.0	9.0	3.23	3.17	1.37	4.0	8.0	Q3
SN74AHC1G08DBVT	SOT-23	DBV	5	250	178.0	9.2	3.3	3.23	1.55	4.0	8.0	Q3
SN74AHC1G08DBVTG4	SOT-23	DBV	5	250	178.0	9.0	3.23	3.17	1.37	4.0	8.0	Q3
SN74AHC1G08DCKR	SC70	DCK	5	3000	178.0	9.2	2.4	2.4	1.22	4.0	8.0	Q3
SN74AHC1G08DCKR	SC70	DCK	5	3000	178.0	9.0	2.4	2.5	1.2	4.0	8.0	Q3
SN74AHC1G08DCKRG4	SC70	DCK	5	3000	178.0	9.2	2.4	2.4	1.22	4.0	8.0	Q3
SN74AHC1G08DCKT	SC70	DCK	5	250	178.0	9.2	2.4	2.4	1.22	4.0	8.0	Q3
SN74AHC1G08DCKT	SC70	DCK	5	250	178.0	9.0	2.4	2.5	1.2	4.0	8.0	Q3
SN74AHC1G08DCKT	SC70	DCK	5	250	178.0	9.0	2.4	2.5	1.2	4.0	8.0	Q3
SN74AHC1G08DCKTG4	SC70	DCK	5	250	178.0	9.2	2.4	2.4	1.22	4.0	8.0	Q3
SN74AHC1G08DRLR	SOT-5X3	DRL	5	4000	180.0	8.4	1.98	1.78	0.69	4.0	8.0	Q3

**TAPE AND REEL BOX DIMENSIONS**

\*All dimensions are nominal

Device	Package Type	Package Drawing	Pins	SPQ	Length (mm)	Width (mm)	Height (mm)
SN74AHC1G08DBVR	SOT-23	DBV	5	3000	180.0	180.0	18.0
SN74AHC1G08DBVR	SOT-23	DBV	5	3000	180.0	180.0	18.0
SN74AHC1G08DBVRG4	SOT-23	DBV	5	3000	180.0	180.0	18.0
SN74AHC1G08DBVT	SOT-23	DBV	5	250	180.0	180.0	18.0
SN74AHC1G08DBVT	SOT-23	DBV	5	250	202.0	201.0	28.0
SN74AHC1G08DBVT	SOT-23	DBV	5	250	180.0	180.0	18.0
SN74AHC1G08DBVT	SOT-23	DBV	5	250	180.0	180.0	18.0
SN74AHC1G08DBVTG4	SOT-23	DBV	5	250	180.0	180.0	18.0
SN74AHC1G08DCKR	SC70	DCK	5	3000	180.0	180.0	18.0
SN74AHC1G08DCKR	SC70	DCK	5	3000	180.0	180.0	18.0
SN74AHC1G08DCKRG4	SC70	DCK	5	3000	180.0	180.0	18.0
SN74AHC1G08DCKT	SC70	DCK	5	250	180.0	180.0	18.0
SN74AHC1G08DCKT	SC70	DCK	5	250	180.0	180.0	18.0
SN74AHC1G08DCKT	SC70	DCK	5	250	180.0	180.0	18.0
SN74AHC1G08DCKTG4	SC70	DCK	5	250	180.0	180.0	18.0
SN74AHC1G08DRLR	SOT-5X3	DRL	5	4000	202.0	201.0	28.0

DCK (R-PDSO-G5)

PLASTIC SMALL-OUTLINE PACKAGE



- NOTES:
- A. All linear dimensions are in millimeters.
  - B. This drawing is subject to change without notice.
  - C. Body dimensions do not include mold flash or protrusion. Mold flash and protrusion shall not exceed 0.15 per side.
  - D. Falls within JEDEC MO-203 variation AA.

DCK (R-PDSO-G5)

PLASTIC SMALL OUTLINE



- NOTES:
- All linear dimensions are in millimeters.
  - This drawing is subject to change without notice.
  - Customers should place a note on the circuit board fabrication drawing not to alter the center solder mask defined pad.
  - Publication IPC-7351 is recommended for alternate designs.
  - Laser cutting apertures with trapezoidal walls and also rounding corners will offer better paste release. Customers should contact their board assembly site for stencil design recommendations. Example stencil design based on a 50% volumetric metal load solder paste. Refer to IPC-7525 for other stencil recommendations.



- NOTES:
- A. All linear dimensions are in millimeters. Dimensioning and tolerancing per ASME Y14.5M-1994.
  - B. This drawing is subject to change without notice.
  - C. Body dimensions do not include mold flash, interlead flash, protrusions, or gate burrs. Mold flash, interlead flash, protrusions, or gate burrs shall not exceed 0,15 per end or side.
  - D. JEDEC package registration is pending.

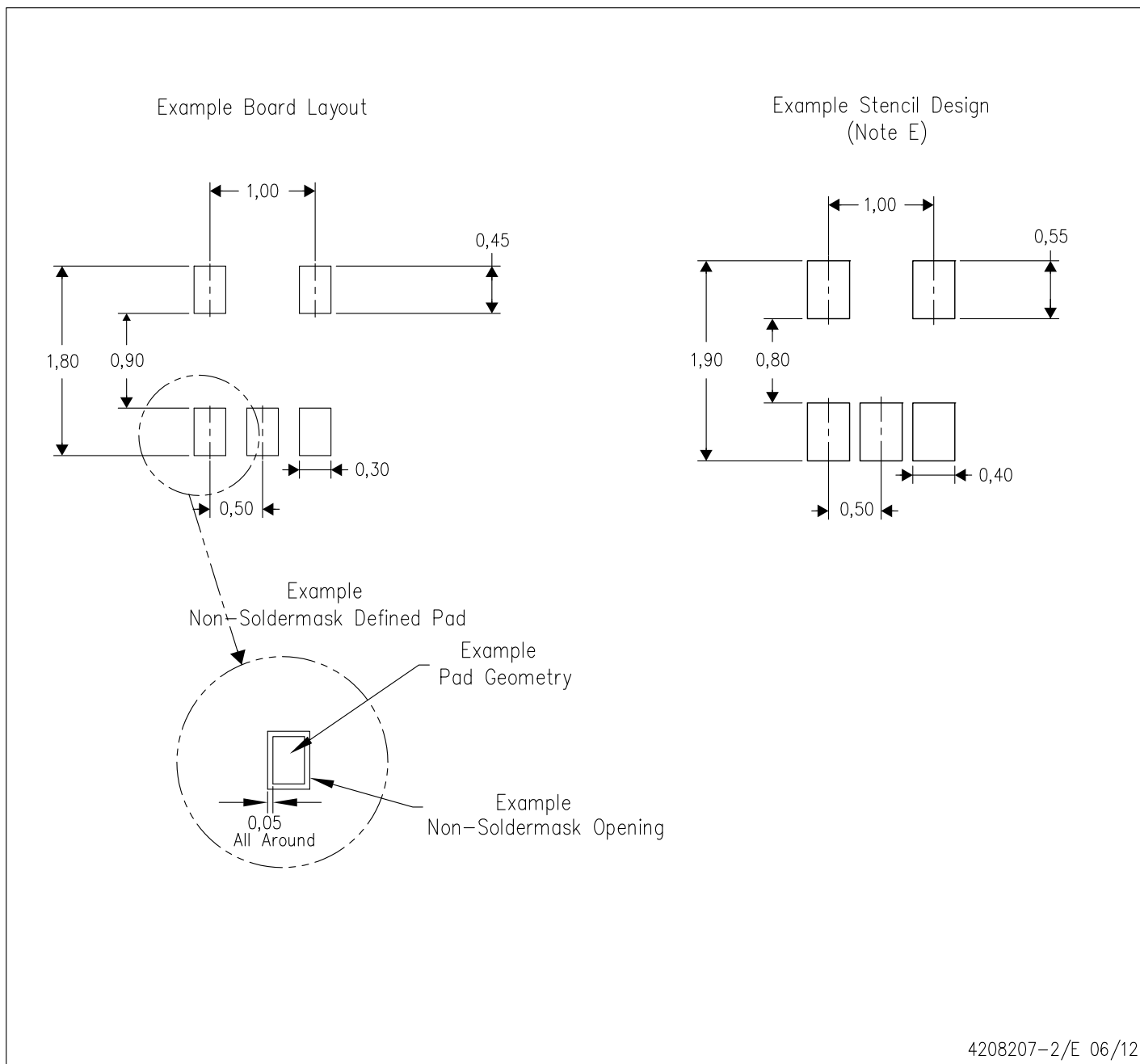

- NOTES:
- A. All linear dimensions are in millimeters.
  - B. This drawing is subject to change without notice.
  - C. Publication IPC-7351 is recommended for alternate designs.
  - D. Customers should contact their board fabrication site for minimum solder mask web tolerances between signal pads.
  - E. Maximum stencil thickness 0,127 mm (5 mils). All linear dimensions are in millimeters.
  - F. Laser cutting apertures with trapezoidal walls and also rounding corners will offer better paste release. Customers should contact their board assembly site for stencil design recommendations. Refer to IPC 7525 for stencil design considerations.
  - G. Side aperture dimensions over-print land for acceptable area ratio > 0.66. Customer may reduce side aperture dimensions if stencil manufacturing process allows for sufficient release at smaller opening.

DBV0005A



# PACKAGE OUTLINE

SOT-23 - 1.45 mm max height

SMALL OUTLINE TRANSISTOR



4214839/D 11/2018

NOTES:

1. All linear dimensions are in millimeters. Any dimensions in parenthesis are for reference only. Dimensioning and tolerancing per ASME Y14.5M.
2. This drawing is subject to change without notice.
3. Reference JEDEC MO-178.
4. Body dimensions do not include mold flash, protrusions, or gate burrs. Mold flash, protrusions, or gate burrs shall not exceed 0.15 mm per side.

# EXAMPLE BOARD LAYOUT

DBV0005A

SOT-23 - 1.45 mm max height

SMALL OUTLINE TRANSISTOR



LAND PATTERN EXAMPLE  
EXPOSED METAL SHOWN  
SCALE:15X

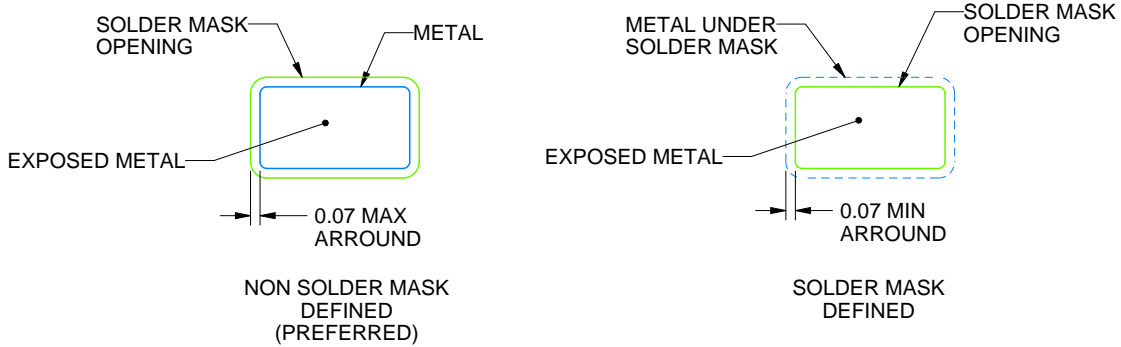

SOLDER MASK DETAILS

4214839/D 11/2018

NOTES: (continued)

- 5. Publication IPC-7351 may have alternate designs.
- 6. Solder mask tolerances between and around signal pads can vary based on board fabrication site.

# EXAMPLE STENCIL DESIGN

DBV0005A

SOT-23 - 1.45 mm max height

SMALL OUTLINE TRANSISTOR



SOLDER PASTE EXAMPLE  
BASED ON 0.125 mm THICK STENCIL  
SCALE:15X

4214839/D 11/2018

NOTES: (continued)

7. Laser cutting apertures with trapezoidal walls and rounded corners may offer better paste release. IPC-7525 may have alternate design recommendations.
8. Board assembly site may have different recommendations for stencil design.

## IMPORTANT NOTICE AND DISCLAIMER

TI PROVIDES TECHNICAL AND RELIABILITY DATA (INCLUDING DATASHEETS), DESIGN RESOURCES (INCLUDING REFERENCE DESIGNS), APPLICATION OR OTHER DESIGN ADVICE, WEB TOOLS, SAFETY INFORMATION, AND OTHER RESOURCES "AS IS" AND WITH ALL FAULTS, AND DISCLAIMS ALL WARRANTIES, EXPRESS AND IMPLIED, INCLUDING WITHOUT LIMITATION ANY IMPLIED WARRANTIES OF MERCHANTABILITY, FITNESS FOR A PARTICULAR PURPOSE OR NON-INFRINGEMENT OF THIRD PARTY INTELLECTUAL PROPERTY RIGHTS.

These resources are intended for skilled developers designing with TI products. You are solely responsible for (1) selecting the appropriate TI products for your application, (2) designing, validating and testing your application, and (3) ensuring your application meets applicable standards, and any other safety, security, or other requirements. These resources are subject to change without notice. TI grants you permission to use these resources only for development of an application that uses the TI products described in the resource. Other reproduction and display of these resources is prohibited. No license is granted to any other TI intellectual property right or to any third party intellectual property right. TI disclaims responsibility for, and you will fully indemnify TI and its representatives against, any claims, damages, costs, losses, and liabilities arising out of your use of these resources.

TI's products are provided subject to TI's Terms of Sale ([www.ti.com/legal/termsofsale.html](http://www.ti.com/legal/termsofsale.html)) or other applicable terms available either on [ti.com](http://ti.com) or provided in conjunction with such TI products. TI's provision of these resources does not expand or otherwise alter TI's applicable warranties or warranty disclaimers for TI products.

Mailing Address: Texas Instruments, Post Office Box 655303, Dallas, Texas 75265  
Copyright © 2019, Texas Instruments Incorporated