

# RL78/G14 Stick

## (YRPBRL78G14)

16

16-bit Microcontroller

RL78/G14

R5F104LEAFB

All information contained in these materials, including products and product specifications, represents information on the product at the time of publication and is subject to change by Renesas Electronics Corp. without notice. Please review the latest information published by Renesas Electronics Corp. through various means, including the Renesas Technology Corp. website (<http://www.renesas.com>).

## Notice

1. All information included in this document is current as of the date this document is issued. Such information, however, is subject to change without any prior notice. Before purchasing or using any Renesas Electronics products listed herein, please confirm the latest product information with a Renesas Electronics sales office. Also, please pay regular and careful attention to additional and different information to be disclosed by Renesas Electronics such as that disclosed through our website.
2. Renesas Electronics does not assume any liability for infringement of patents, copyrights, or other intellectual property rights of third parties by or arising from the use of Renesas Electronics products or technical information described in this document. No license, express, implied or otherwise, is granted hereby under any patents, copyrights or other intellectual property rights of Renesas Electronics or others.
3. You should not alter, modify, copy, or otherwise misappropriate any Renesas Electronics product, whether in whole or in part.
4. Descriptions of circuits, software and other related information in this document are provided only to illustrate the operation of semiconductor products and application examples. You are fully responsible for the incorporation of these circuits, software, and information in the design of your equipment. Renesas Electronics assumes no responsibility for any losses incurred by you or third parties arising from the use of these circuits, software, or information.
5. When exporting the products or technology described in this document, you should comply with the applicable export control laws and regulations and follow the procedures required by such laws and regulations. You should not use Renesas Electronics products or the technology described in this document for any purpose relating to military applications or use by the military, including but not limited to the development of weapons of mass destruction. Renesas Electronics products and technology may not be used for or incorporated into any products or systems whose manufacture, use, or sale is prohibited under any applicable domestic or foreign laws or regulations.
6. Renesas Electronics has used reasonable care in preparing the information included in this document, but Renesas Electronics does not warrant that such information is error free. Renesas Electronics assumes no liability whatsoever for any damages incurred by you resulting from errors in or omissions from the information included herein.
7. Renesas Electronics products are classified according to the following three quality grades: "Standard", "High Quality", and "Specific". The recommended applications for each Renesas Electronics product depends on the product's quality grade, as indicated below. You must check the quality grade of each Renesas Electronics product before using it in a particular application. You may not use any Renesas Electronics product for any application categorized as "Specific" without the prior written consent of Renesas Electronics. Further, you may not use any Renesas Electronics product for any application for which it is not intended without the prior written consent of Renesas Electronics. Renesas Electronics shall not be in any way liable for any damages or losses incurred by you or third parties arising from the use of any Renesas Electronics product for an application categorized as "Specific" or for which the product is not intended where you have failed to obtain the prior written consent of Renesas Electronics.

8. The quality grade of each Renesas Electronics product is “Standard” unless otherwise expressly specified in a Renesas Electronics data sheets or data books, etc.
- “Standard”: Computers; office equipment; communications equipment; test and measurement equipment; audio and visual equipment; home electronic appliances; machine tools; personal electronic equipment; and industrial robots.
- “High Quality”: Transportation equipment (automobiles, trains, ships, etc.); traffic control systems; anti-disaster systems; anti- crime systems; safety equipment; and medical equipment not specifically designed for life support.
- “Specific”: Aircraft; aerospace equipment; submersible repeaters; nuclear reactor control systems; medical equipment or systems for life support (e.g. artificial life support devices or systems), surgical implantations, or healthcare intervention (e.g. excision, etc.), and any other applications or purposes that pose a direct threat to human life.
9. You should use the Renesas Electronics products described in this document within the range specified by Renesas Electronics, especially with respect to the maximum rating, operating supply voltage range, movement power voltage range, heat radiation characteristics, installation and other product characteristics. Renesas Electronics shall have no liability for malfunctions or damages arising out of the use of Renesas Electronics products beyond such specified ranges.
10. Although Renesas Electronics endeavours to improve the quality and reliability of its products, semiconductor products have specific characteristics such as the occurrence of failure at a certain rate and malfunctions under certain use conditions. Further, Renesas Electronics products are not subject to radiation resistance design. Please be sure to implement safety measures to guard them against the possibility of physical injury, and injury or damage caused by fire in the event of the failure of a Renesas Electronics product, such as safety design for hardware and software including but not limited to redundancy, fire control and malfunction prevention, appropriate treatment for aging degradation or any other appropriate measures. Because the evaluation of microcomputer software alone is very difficult, please evaluate the safety of the final products or system manufactured by you.
11. Please contact a Renesas Electronics sales office for details as to environmental matters such as the environmental compatibility of each Renesas Electronics product. Please use Renesas Electronics products in compliance with all applicable laws and regulations that regulate the inclusion or use of controlled substances, including without limitation, the EU RoHS Directive. Renesas Electronics assumes no liability for damages or losses occurring as a result of your noncompliance with applicable laws and regulations.
12. This document may not be reproduced or duplicated, in any form, in whole or in part, without prior written consent of Renesas Electronics.
13. Please contact a Renesas Electronics sales office if you have any questions regarding the information contained in this document or Renesas Electronics products, or if you have any other inquiries.
- (Note 1) “Renesas Electronics” as used in this document means Renesas Electronics Corporation and also includes its majority- owned subsidiaries.
- (Note 2) “Renesas Electronics product(s)” means any product developed or manufactured by or for Renesas Electronics.

## General Precautions in the Handling of MPU/MCU Products

The following usage notes are applicable to all MPU/MCU products from Renesas. For detailed usage notes on the products covered by this manual, refer to the relevant sections of the manual. If the descriptions under General Precautions in the Handling of MPU/MCU Products and in the body of the manual differ from each other, the description in the body of the manual takes precedence.

### 1. Handling of Unused Pins

Handle unused pins in accord with the directions given under Handling of Unused Pins in the manual.

The input pins of CMOS products are generally in the high-impedance state. In operation with an unused pin in the open-circuit state, extra electromagnetic noise is induced in the vicinity of LSI, associated shoot-through current flows internally, and malfunctions occur due to the false recognition of the pin state as an input signal become possible. Unused pins should be handled as described under Handling of Unused Pins in the manual.

### 2. Processing at Power-on

The state of the product is undefined at the moment when power is supplied.

The states of internal circuits in the LSI are indeterminate and the states of register settings and pins are undefined at the moment when power is supplied.

In a finished product where the reset signal is applied to the external reset pin, the states of pins are not guaranteed from the moment when power is supplied until the reset process is completed.

In a similar way, the states of pins in a product that is reset by an on-chip power-on reset function are not guaranteed from the moment when power is supplied until the power reaches the level at which resetting has been specified.

### 3. Prohibition of Access to Reserved Addresses

Access to reserved addresses is prohibited.

The reserved addresses are provided for the possible future expansion of functions. Do not access these addresses; the correct operation of LSI is not guaranteed if they are accessed.

### 4. Clock Signals

After applying a reset, only release the reset line after the operating clock signal has become stable. When switching the clock signal during program execution, wait until the target clock signal has stabilized.

When the clock signal is generated with an external resonator (or from an external oscillator) during a reset, ensure that the reset line is only released after full stabilization of the clock signal. Moreover, when switching to a clock signal produced with an external resonator (or by an external oscillator) while program execution is in progress, wait until the target clock signal is stable.

### 5. Differences between Products

Before changing from one product to another, i.e. to one with a different part number, confirm that the change will not lead to problems.

The characteristics of MPU/MCU in the same group but having different part numbers may differ because of the differences in internal memory capacity and layout pattern. When changing to products of different part numbers, implement a system-evaluation test for each of the products.

## Regional Information

Some information contained in this document may vary from country to country. Before using any Renesas Electronics product in your application, please contact the Renesas Electronics office in your country to obtain a list of authorized representatives and distributors. They will verify:

- Device availability
- Ordering information
- Product release schedule
- Availability of related technical literature
- Development environment specifications (for example, specifications for third-party tools and components, host computers, power plugs, AC supply voltages, and so forth)
- Network requirements

In addition, trademarks, registered trademarks, export restrictions, and other legal issues may also vary from country to country.

Visit

<http://www.renesas.com>

or get in contact with your regional representatives and distributors.

## China RoHS Information

### ● 有毒有害物質又は元素の含有表

Table of Toxic and Hazardous Substance and Elements

部品名称 Part Name  	有毒有害物質又は元素 Toxic and Hazardous Substance and Elements					
	鉛 Lead (Pb)	水銀 Mercury (Hg)	カドミウム Cadmium (Cd)	六価クロム Hexavalent Chromium (Cr(VI))	ポリ臭化ビフェニル Polybrominated biphenyls (PBB)	ポリ臭化ジフェニルエーテル Polybrominated diphenyl ethers (PBDE)
筐体 Case	○	○	○	○	○	○
ボード Board	X	○	○	○	○	○
ケーブル Cable	X	○	○	○	○	○
ソケット Socket	X	○	○	○	○	○
ACアダプタ AC-Adapter	X	○	○	○	○	○

O: 当該部材の全ての均質材料中における該当有毒有害な物質の含有量がいずれも SJ/T11363-2006 基準に規定する限度量の要求以下であることを表します。  
 If certain toxic and hazardous substances or elements do not exist in this part, then mark "O" for the corresponding column, which indicates that this toxic and hazardous substance or element contained in all of the homogeneous materials for this part is below the limit requirement in SJ/T11363-2006.

X: 少なくとも当該部材のある均質材料中における当該有毒有害な物質の含有量が SJ/T11363-2006 基準に規定する限度量の要求を上回ることを表します。  
 If certain toxic and hazardous substance or element is contained in this part, then "X" for the corresponding column, which indicates that this toxic and hazardous substance or element contained in at least one of the homogeneous materials used for this part is above the limit requirement in SJ/T11363-2006.

このマークは、中華人民共和国で販売される電子情報製品に適用され、マーク中央の数字は環境保護使用期限の年数です。なお、本製品の年数は、通常に使用された場合の年数です。  
 This mark is applied to EIPs sold in People's Republic of China, and the number in the center indicates the years of the environment-friendly use period. The years for this product is applicable when the product is used normally.

注) この表には電子情報製品全ての添付品を記載しており、製品によっては同梱されていないものがございますのでご了承下さい。

Notice) All of the attached items relating to 'Electronic Information Products' are listed in this table.  
 Please understand that there is not always bundled all of the items because it depends on the product.

### ● 识别生产日期的方法 About Confirmation method of produced year

请通过产品或产品外包装箱上的序列号识别生产日期。

Please confirm the produced year from nameplate label etc on product body or outer box.

如) 生产日期为 2012 年      Produced 2012

# Preface

- Readers** This manual is intended for users who want to understand the functions of the concerned microcontrollers.
- Purpose** This manual presents the hardware manual for the concerned microcontrollers.
- Organisation** This system specification describes the following sections:
- Pin function
  - CPU function
  - Internal peripheral function
- Module instances** These microcontrollers may contain several instances of a dedicated module. In general the different instances of such modules are identified by the index “n”, where “n” counts from 0 to the number of instances minus one.
- Legend** Symbols and notation are used as follows:
- Weight in data notation: Left is high order column, right is low order column
  - Active low notation: xxx (pin or signal name is over-scored) or /xxx (slash before signal name) or \_xxx
  - Memory map address: High order at high stage and low order at low stage
- Note** Additional remark or tip
- Caution** Item deserving extra attention
- Numeric notation**
- |             |                  |
|-------------|------------------|
| Binary:     | xxxx or xxxB     |
| Decimal:    | xxxx             |
| Hexadecimal | xxxxH or 0x xxxx |
- Numeric prefixes** Representing powers of 2 (address space, memory capacity):
- |           |                                   |
|-----------|-----------------------------------|
| K (kilo): | $2^{10} = 1024$                   |
| M (mega): | $2^{20} = 1024^2 = 1,048,576$     |
| G (giga): | $2^{30} = 1024^3 = 1,073,741,824$ |
- Register contents** X, x = don't care
- Diagrams** Block diagrams do not necessarily show the exact wiring in hardware but the functional structure. Timing diagrams are for functional explanation purposes only, without any relevance to the real hardware implementation.

# How to Use This Manual

## (1) Purpose and Target Readers

This manual is designed to provide the user with an understanding of the hardware functions and electrical characteristics of the MCU. It is intended for users designing application systems incorporating the MCU. A basic knowledge of electric circuits, logical circuits, and MCUs is necessary in order to use this manual. The manual comprises an overview of the product; descriptions of the CPU, system control functions, peripheral functions, and electrical characteristics; and usage notes.

Particular attention should be paid to the precautionary notes when using the manual. These notes occur within the body of the text, at the end of each section, and in the Usage Notes section.

The revision history summarizes the locations of revisions and additions. It does not list all revisions. Refer to the text of the manual for details.

The following documents apply to the RL78/G14 Group. Make sure to refer to the latest versions of these documents. The newest versions of the documents listed may be obtained from the Renesas Electronics Web site.

Document Type	Description	Document Title	Document No.
Data Sheet	Hardware overview and electrical characteristics	RL78/G14 Group Datasheet	R01DS0053EJ0100
User's manual for Hardware	Hardware specifications (pin assignments, memory maps, peripheral function specifications, electrical characteristics, timing charts) and operation description. Note: Refer to the application notes for details on using peripheral functions.	RL78/G14 User's Manual for Hardware	R01UH0186EJ0100
User's manual for Promotion Board	Hardware specifications (pin assignments, memory maps, peripheral function specifications, electrical characteristics, timing charts) and operation description. Note: Refer to the application notes for details on using peripheral functions.	RL78/G14 Promotion Board User's Manual	R20UT1449EG0100
User's manual for Software	Description of CPU instruction set	RL78 Series User's Manual for Software	R01US0015EJ0100
Quick Start Guide	Provides simple instructions to setup the RPB and run the sample code.	Quick Start Guide	R20UT2015EG0100
Application Note	Information on using peripheral functions and application examples. Sample programs. Information on writing programs in assembly language and C.	Available from Renesas Electronics Web site.	
Renesas Technical Update	Product specifications, updates on documents, etc.		

**(2) Notation of Numbers and Symbols**

Not applicable.

**(3) Register Notation**

Not applicable.

**(4) List of Abbreviations and Acronyms**

Abbreviation	Full Form
ACIA	Asynchronous Communication Interface Adapter
bps	bits per second
CRC	Cyclic Redundancy Check
DMA	Direct Memory Access
DMAC	Direct Memory Access Controller
DTC	Data Transfer Controller
ELC	Event Link Controller
GSM	Global System for Mobile Communications
Hi-Z	High Impedance
IEBus	Inter Equipment Bus
IDE	Integrated Development Environment
I/O	Input/Output
IrDA	Infrared Data Association
LSB	Least Significant Bit
MSB	Most Significant Bit
NC	Non-Connect
PLL	Phase Locked Loop
PWM	Pulse Width Modulation
RFP	Renesas Flash Programmer
SFR	Special Function Register
SIM	Subscriber Identity Module
UART	Universal Asynchronous Receiver/Transmitter
VCO	Voltage Controlled Oscillator

All trademarks and registered trademarks are the property of their respective owners.

## Table of Contents

<b>Chapter 1</b>	<b>Introduction .....</b>	<b>12</b>
1.1	Main features of <i>YRPBRL78G14</i> .....	12
1.2	System requirements .....	13
1.3	Package contents .....	13
<b>Chapter 2</b>	<b><i>YRPBRL78G14</i> System Configuration.....</b>	<b>14</b>
2.1	<i>YRPBRL78G14</i> .....	14
2.2	Host Computer.....	14
2.3	Power Supply via USB interface .....	14
<b>Chapter 3</b>	<b><i>YRPBRL78G14</i> Board Components.....</b>	<b>15</b>
3.1	Configuration Jumpers CN6, CN7, CN8, CN11.....	15
3.1.1	GUI Demonstration Mode / Virtual UART Mode.....	15
3.1.2	On-Board Debug (OCD) and Flash Programming Modes .....	16
3.2	Power LED D1 .....	16
3.3	User's LED D2.....	16
3.4	External Power Supply CN5.....	16
3.5	Current Measurement CN4 .....	17
3.6	E1 Emulator Connector CN1.....	17
3.7	Mini-B USB Interface Connector USB.....	18
3.8	External Jumpers CN2 and CN3.....	19
3.9	Solder Bridges .....	21
3.10	Seiko Instruments Inc. Low Power 32 KHz Resonator .....	22
3.11	RL78/G14 Memory Map .....	22
<b>Chapter 4</b>	<b>Getting Started.....</b>	<b>23</b>
4.1	Installed Contents .....	23
<b>Chapter 5</b>	<b>Hardware Installation .....</b>	<b>24</b>
<b>Chapter 6</b>	<b>Software Installation .....</b>	<b>25</b>
6.1	Sample Programs Installation .....	25
6.1.1	Confirmation of USB Driver Installation.....	26
<b>Chapter 7</b>	<b>How to Use the Renesas Flash Programmer Software... 27</b>	
7.1	Debugging in e <sup>2</sup> studio.....	33
<b>Chapter 8</b>	<b>GUI Description .....</b>	<b>43</b>
8.1	Running the RL78/G14 Demo .....	43
8.2	GUI Demo Sections .....	44
8.3	ADC Demonstration .....	46
8.4	Real Time Clock Demonstration.....	47
8.5	Memory Demonstration .....	48

<b>8.6</b>	<b>Low Power Demonstration .....</b>	<b>49</b>
8.6.1	HALT Mode.....	50
8.6.2	STOP Mode.....	50
8.6.3	SNOOZE Mode .....	51
<b>8.7</b>	<b>Self-Test Functions Demonstration .....</b>	<b>52</b>
<b>Chapter 9</b>	<b>Troubleshooting .....</b>	<b>55</b>
<b>Chapter 10</b>	<b>Schematics .....</b>	<b>65</b>
<b>Chapter 11</b>	<b>Resonator from Seiko Instruments Inc .....</b>	<b>67</b>
11.1	Features of the 32 KHz Resonator.....	67
11.2	Product Name and Specifications .....	67
11.3	Web URL .....	67
11.4	Seiko Instruments Inc. Contact Addresses .....	68

# Chapter 1 Introduction

The *YRPBRL78G14* is a promotion board for the new Renesas RL78 microcontroller family. It supports On-Board debugging, flash programming, and is pre-programmed to work with the GUI provided on the DVD to demonstrate the low power capabilities of the Renesas RL78 MCU.

## 1.1 Main features of *YRPBRL78G14*

- Easy to use device demonstration capabilities  
*YRPBRL78G14* contains elements to easily demonstrate simple I/O-functions (i.e. LED output, I/O lines, UART serial interface) together with the key functions such as Real Time Clock (RTC), ADC, DTC, ELC, Timers and safety functions.
- Power supply via USB interface  
*YRPBRL78G14* is powered via USB interface. No separate power supply is needed although a connector is provided to supply an external power supply if needed.
- Renesas Flash Programmer V1.03.00, Flash programming software  
Windows based Flash programming software allows the user to select and download application programs to the *YRPBRL78G14* board for evaluation purposes.
- Applilet3, Device driver code generator  
Software tool used to generate device driver code to initialize and use on-chip peripherals.

**Caution** Please note that the Renesas Applilet3 for RL78/G14 V1.01.01 software, used to generate drivers for this board, is at a preliminary version and can be downloaded from the Renesas website. We recommend not upgrading these software tools in order to guarantee operation with the stick. Documentation is not supplied for preliminary versions, but can be downloaded from the Renesas website once final versions are released.

Any of the software supplied with this product can be updated from the Renesas Tools web site. However please be aware that while every effort is made to maintain compatibility between revisions, it is not guaranteed that new software versions will be backward compatible with previous releases of the *YRPBRL78G14* board.

- Various input / output signals available, such as
  - All I/O ports prepared to be connected to user hardware
  - Virtual UART interface, via the  $\mu$ PD78F0730 78K0 8-bit microcontroller with on-board USB interface
  - 1 LED connected to a RL78/G14 port for visualisation.
- Full documentation is included for all of the released Renesas software tools and the RL78/G14 device.

***YRPBRL78G14* is not intended for code development. Renesas does not allow and does not support in any way any attempt to use *YRPBRL78G14* in a commercial or technical product.**

## 1.2 System requirements

<b>HOST PC</b>	<p>A PC supporting Windows XP, Windows Vista or 7 is required for the GUI and development tools installation. A Pentium processor with at least 1 GHz CPU performance, with at least 256 Mbytes of RAM, allowing you to fully utilize and take advantage of the product features.</p> <p>350 Mbytes of free disk space and an additional 10 Mbytes of free disk space on the Windows system drive.</p> <p>A web browser</p>
<b>Display Properties</b>	<p>Display with 1024x768 minimum resolution.</p> <p>Normal size (96Dpi) Display Dpi settings.</p>
<b>Host interface</b>	<p>USB interface that enables communication based on USB (Ver1.1 or later)</p>

## 1.3 Package contents

- *YRPBRL78G14*
- USB Type A / Mini-B cable
- Screwdriver to adjust the potentiometer voltage
- DVD containing all the software, tools and documentation needed to quickly start evaluating the product.

If any part is missing or seems to be damaged, please contact the dealer from whom you received your *YRPBRL78G14* promotion board.

## Chapter 2 YRPBRL78G14 System Configuration

The YRPBRL78G14 system configuration is given in the diagram below:

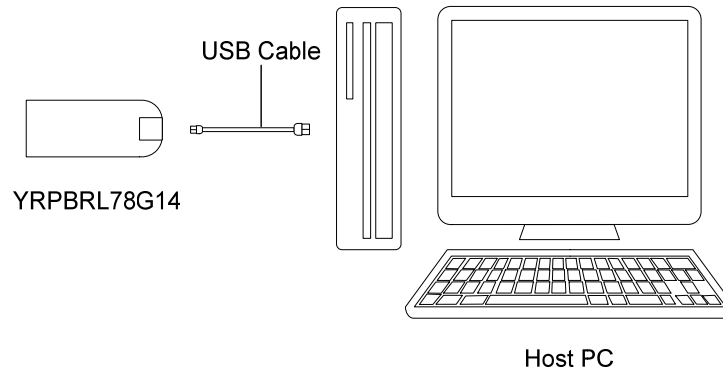

Figure 1: YRPBRL78G14 System Configuration

### 2.1 YRPBRL78G14

YRPBRL78G14 is a promotion board for evaluating the new Renesas RL78/G14 family of devices. The device used is the RL78/G14 (R5F104LEAFB). The board can be directly connected to the host system via a USB port. The host system allows execution of the Demonstration program on the RL78/G14 device in combination with the supplied demonstration GUI.

As default, the RL78/G14 is using the 32 MHz internal high-speed oscillator, but the YRPBRL78G14 board is provided with a connection for an external 20 MHz oscillator (not fitted) if the user wishes to use a different clock frequency than that provided by the internal high speed oscillator. An external Seiko Instruments low power 32.768 KHz resonator is provided for the sub-clock.

### 2.2 Host Computer

The USB host interface enables communication to the YRPBRL78G14 board. The  $\mu$ PD78F0730 78K0 8-bit microcontroller with on-chip USB interface and the Renesas Electronics virtual UART driver allows application software to access the USB device in the same way as it would access a standard RS232 interface. The Renesas Electronics virtual UART driver appears to the windows system as an extra Com Port, in addition to any existing hardware Com Ports.

### 2.3 Power Supply via USB interface

YRPBRL78G14 is powered by USB interface therefore no separate power supply is required.

## Chapter 3 YRPBRL78G14 Board Components

The YRPBRL78G14 board is equipped with a USB connector and with several jumpers in order to be connected to host computers, E1 emulator or any external target hardware.

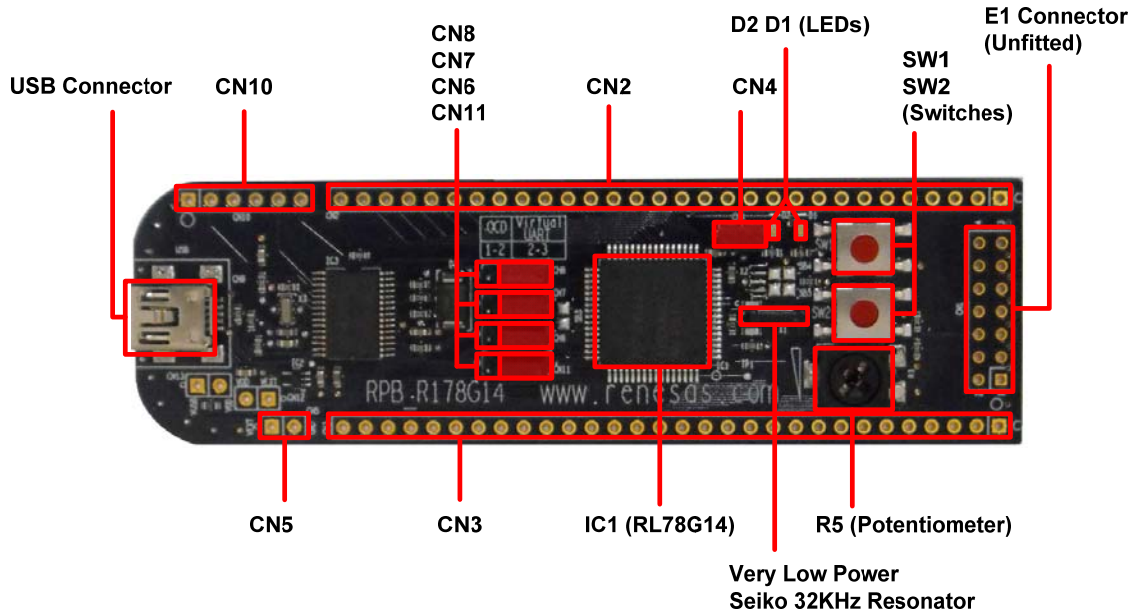

Figure 2: YRPBRL78G14 Board Components

Some of the YRPBRL78G14 components are available for user application hardware and software. Please read the user's manual of the RL78/G14 device carefully to get information about the electrical specification of the available I/O ports before you connect any external signal to the YRPBRL78G14 board.

### 3.1 Configuration Jumpers CN6, CN7, CN8, CN11

The jumpers CN6, CN7, CN8 & CN11 control the different operating modes of the YRPBRL78G14 board.

#### 3.1.1 GUI Demonstration Mode / Virtual UART Mode

The default operation of the board is set for use with the GUI using the virtual UART. Jumpers should be set as shown in the table below

Jumpers	Configuration
CN6	2-3
CN7	2-3
CN8	2-3
CN11	2-3

Table 1: Jumper configuration for GUI Demonstration Mode

### 3.1.2 On-Board Debug (OCD) and Flash Programming Modes

The *YRPBRL78G14* promotion board supports on-board debug mode achieved by a dedicated monitor running on the RL78/G14 device. By using the e<sup>2</sup> studio IDE, flash programming and standard debug functions i.e. code execution, single stepping, software breakpoints, memory manipulation etc. are supported.

Configure jumpers CN6, CN7, CN8, CN11 as following to use the on-board debug or Flash programming mode:

Jumpers	Configuration
CN6	1-2
CN7	1-2
CN8	1-2
CN11	1-2

Table 2: Jumper Configuration for On-Board Debug / Flash Programming Mode

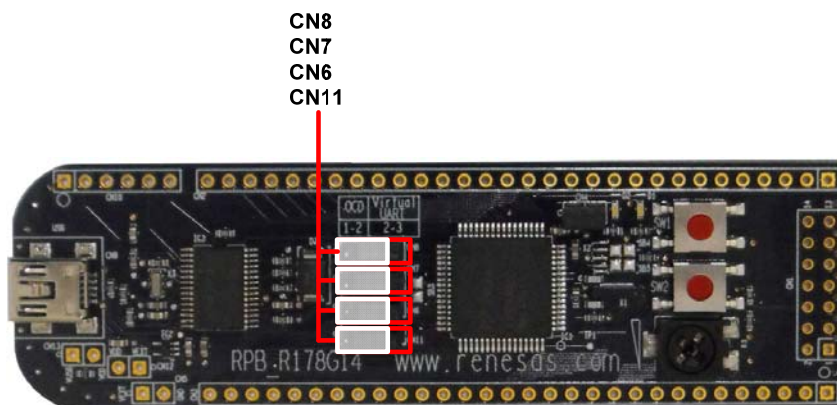

Figure 3: *YRPBRL78G14* On-chip Debugger Jumper Settings

For details on debugging in e<sup>2</sup> studio please refer to **Chapter 7 – Debugging in e<sup>2</sup> studio** of this document.

### 3.2 Power LED D1

D1 is the Power LED. D1 is activated if power is supplied to the *YRPBRL78G14* board.

### 3.3 User's LED D2

D2 is connected to the port pin "P77" of the RL78/G14. It can be used by the user for any purpose.

### 3.4 External Power Supply CN5

External power can be supplied by connecting a regulated 5V DC to the connector CN5 (not assembled).

The operation of the stick is as follows:

- USB power only

**Or**

- External supply only (Board can only be operated as stand alone only, no USB power connection).

When external power supply (Vext) is used, make sure that you follow these guidelines:

- Vext can only be used if the stick is not connected to the PC
- USB connection is not permitted (if both USB and external power supplies are used, then it can damage the board).

Please refer to the schematic and the assembly drawing of the board to locate the above components.

CN5	Function
1	Vext (+)
2	GND (-)

**Table 3: External Power Supply, Connector J4**

Note: Pin number 1 is marked with a square on the assembly drawing

### 3.5 Current Measurement CN4

Jumper CN4 connects the 5V power supply to the V<sub>DD</sub> pin of the RL78/G14 microcontroller. The jumper can be replaced by the two leads of a multi-meter to measure the current consumed by the RL78 device. To use this function please make sure that the multi-meter is connected before supplying power to the promotion board. The current can be measured for all the different low power modes by using the demonstration GUI supplied to enter all different power and standby modes.

### 3.6 E1 Emulator Connector CN1

Connector Jumper CN1 (not fitted) is provided to allow debugging and programming of the RL78/G14 microcontroller using an E1 emulator. The Renesas Flash programmer V1.03.00 software can be used with the E1 emulator in order to flash the RL78/G14 device with a program file such .mot or .hex. The board power supply can also be provided through this connector.

A 14-way (2 x 7) standard pitch connector needs to be mounted and connected as shown below if the E1 is to be used.

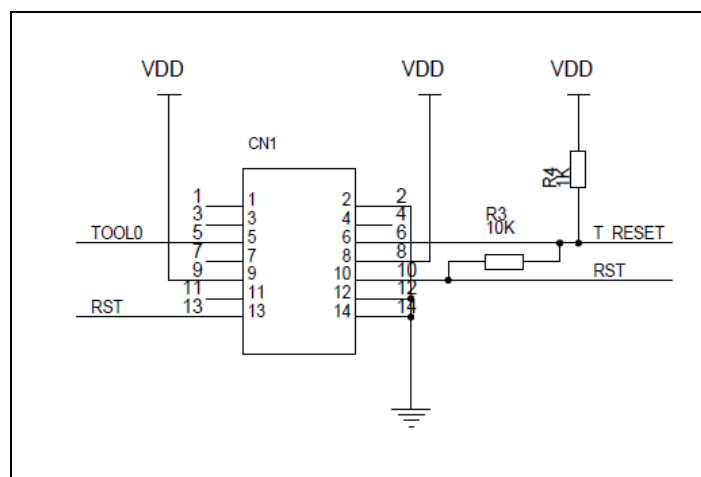

**Figure 4: E1 Emulator Connection**

### 3.7 Mini-B USB Interface Connector USB

The mini-B USB connector allows connecting e<sup>2</sup> studio to the *YRPBRL78G14* board in order to debug or program application software to the RL78/G14 device. The board power supply is also provided by this connector.

Additionally connector USB connects UART2 of the RL78/G14 device to the host system.

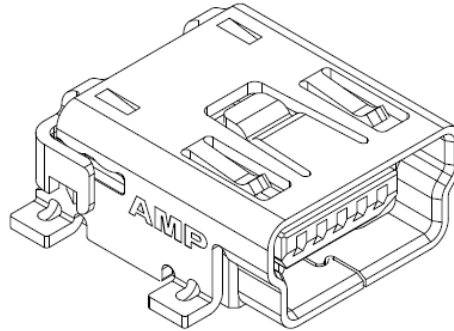

Figure 5: Connector USB, Mini USB B Type Connector Pin Configuration

USB Connector USB	Signal Name
1	V <sub>BUS</sub>
2	D-
3	D+
4	NC
5	GND

Table 4: Pin Configuration of mini-B USB Connector USB

For connection with the host machine, *YRPBRL78G14* can be plugged directly into an available USB port.

### 3.8 External Jumpers CN2 and CN3

CN2 to CN3 are jumpers for external user hardware. A standard 0.1' pitch, 30-way single row, straight headers can be mounted to bring all I/Os for usage. Please read the user's manual of the RL78/G14 device carefully to get information about the electrical specification of the available I/O ports.

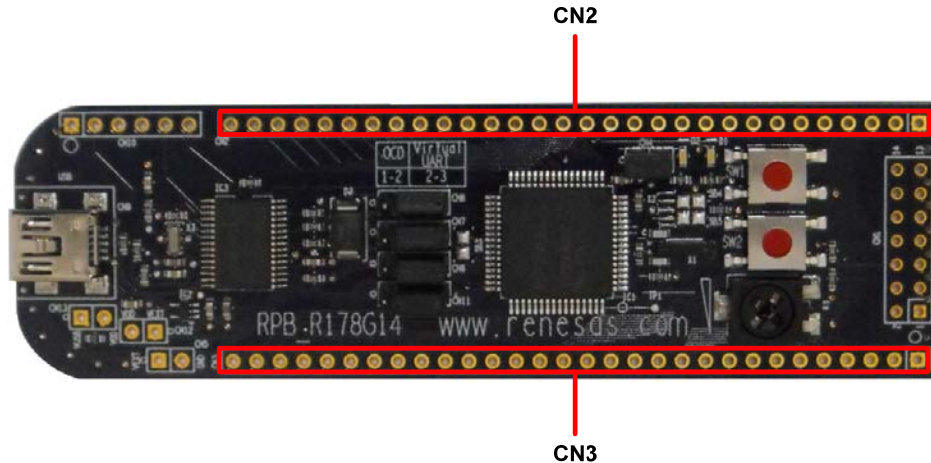

Figure 6: External Jumpers CN2 and CN3

CN2	Signal Name	RL78/G14 Pin Name	Comment
1	GND	VSS / EVSS	
2	VDD	VDD / EVDD	
3	P10	P10_SCK11_Z_SCL11_TRDIOD1	
4	P11	P11_SI11_SDA11_TRDIOD1	
5	P12	P12_SO11_TRDIOD1_IVREF1	
6	TXD	P13_TXD2_SO20_TRDIOA1_IVCMP1	
7	RXD	P14_RXD2_SI20_SDA20_TRDIOD0	
8	P15	P15_SCK20_Z_SCL20_TRDIOD0	
9	P16	P16_TIO1_TO01_INTP5_TRDIOD0_IVREF0	
10	P17	P17_TIO1_TO02_TRDIOA0_TRDCLK0_IVCMP0	
11	P55	P55	
12	P54	P54	
13	P53	P53	
14	P52	P52	
15	P51	P51_INTP2_SO00_TXD0_TOOLTXD_TRGIOD	
16	P50	P50_INTP1_SI00_RXD0_TOOLTXD_SDA00_TRGIOA	
17	P60	P60_SCLA0	
18	P61	P61_SDA0	
19	P62	P62_SSI00_Z	
20	P63	P63	
21	P31	P31_TIO3_TO03_INTP4	
22	P77	P77_KR7_INTP11	
23	P76	P76_KR6_INTP10	
24	P75	P75_KR5_INTP9_SCK01_Z_SCL01	
25	P74	P74_KR4_INTP8_SI01_SDA01	
26	P73	P73_KR3_SO01	
27	P72	P72_KR2_SO21	
28	P71	P71_KR1_SI21_SDA21	
29	P70	P70_KR0_SCK21_SCL21	
30	NC	-	Not connected

Table 5: Connector CN2

CN3	Signal name	RL78/G14 Pin Name	Comment
1	GND	VSS / EVSS	
2	VDD	VDD / EVDD	
3	P140	P140_PCLBUZ0_INTP6	
4	P141	P141_PCLBUZ1_INTP7	
5	P00	P00_TI00_TRGCLKA	
6	P01	P01_TO00_TRGCLKB_TRJIO0	
7	P02	P02_ANI7_SO10_TXD1	
8	P03	P03_ANI16_SI10_RXD1_SDA10	
9	P04	P04_SCK10_Z_SCL10	
10	P130	P130	
11	AVrefp	P20_ANI0_AVREFP	
12	AVrefm	P21_ANI1_AVREFM	
13	P22	P22_ANI2_ANO0	
14	P23	P23_ANI3_ANO1	
15	P24	P24_ANI4	
16	P25	P25_ANI5	
17	P26	P26_ANI6	
18	P27	P27_ANI7	
19	T_RESET	RESET_Z	Reset input Connected to 1.5 kΩ pull-up resistor
20	P120	P120_ANI19_VCOU0	
21	P43	P43	
22	P42	P42	
23	P41	P41	
24	P137	P40_TOOL0	
25	P146	P146	
26	P147	P147_ANI18_VCOU1	
27	P06	P06	
28	P05	P05	
29	P30	P30_INTP3_RTC1HZ_SCK00_Z_SCL00_TRJO0	
30	NC	-	Not connected

Table 6: Connector CN3

### 3.9 Solder Bridges

Some operating functions can be customized by opening or closing the corresponding solder bridge accordingly. For more details please refer to the board schematics, Chapter 11 of this document.

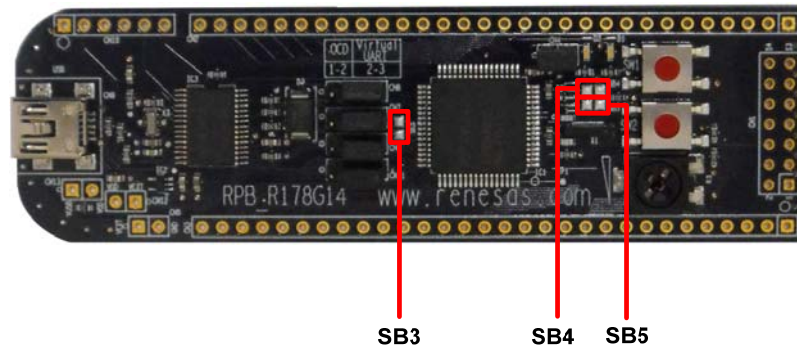

Figure 7: Location of Solder Bridges

Solder Bridge Name	Default Setting	Comment
SB3	Closed	Connects RxD pin to INTP5 pin (for waking up the device from STOP mode upon data reception)
SB4	Closed	Connects X1 pin to a 10K pull-down resistor (when 20MHz resonator not fitted)
SB5	Closed	Connects X2 pin to a 10K pull-down resistor (when 20MHz resonator not fitted)

Table 7: Solder Bridges

### 3.10 Seiko Instruments Inc. Low Power 32 KHz Resonator

The *YRPBRL78G14* board is fitted with an external 32 KHz resonator (X2) characterized specifically for the RL78/G14 device supplied by Seiko Instruments Inc.

This is a specially designed low power resonator designed to support the very low power consumption of the RL78/G14 family.

For more technical details on this device and contact details for Seiko Instruments, please refer to chapter 13.

### 3.11 RL78/G14 Memory Map

The RL78/G14 memory layout is shown in the table below.

Address area	0xFFFF	SFR Area 256 bytes	Free for user application software
	0xFFF00		
	0xFFE00	Internal RAM 5.5KB	
	0xFE900		
	0xFE8FF	Mirror 50.25 KB	
	0xF2000		
	0xF1FFF	Data flash memory 4 KB	
	0xF1000		
	0xF0FFF	Access prohibited area	
	0xF0800		
	0x0F07FF	2nd SFR 2 KB	
	0xF0000		
	0xEFFFF	Access prohibited area	
	0x10000		
	0x0FFFF	64 KB code flash memory	
	0x00000		

Table 8: RL78/G14 Memory Map

## Chapter 4 Getting Started

The default setting of the *YRPBRL78G14* board is set for demonstration use with the GUI. The DVD included and quick start guide will take the user through the installation procedure

The Quick Start Guide will automatically open after the installation process to guide the user through the initial set-up and connection to the PC and GUI.

Please note as the communication interface between the host computer and the *YRPBRL78G14* board is the USB port interface, the software must be installed properly **before** the board is connected to the PC.

### 4.1 Installed Contents

The installer will copy and install the contents of the DVD on the host PC.

The contents copied and installed from the DVD will appear on the “Start → All Programs” menu.









 <b>Renesas</b>	<b>Description</b>
 Renesas Flash Programmer V1.03.00	Flash Programming Software
 <b>Renesas Electronics Tools</b>	
 YRPBRL78G14	
 Manual Navigator	Documentation
 YRPBRL78G14-Demo	GUI Software
 Manuals	Shortcuts to Documents
 <b>Renesas Electronics e2studio</b>	
 Renesas E2 Studio	E2 Studio IDE

Table 9: Contents Installed on Start → All Programs

## Chapter 5 Hardware Installation

Before connecting the *YRPBRL78G14* board to the host PC via USB cable, ensure all the software is correctly installed first (see chapter 6).

## Chapter 6 Software Installation

The *YRPBRL78G14* package comes with several software demonstration packages:

- e<sup>2</sup> studio IDE, including the GNURL78 compiler, assembler, linker, library generator, Renesas GDB Server and E1 emulator drivers.
- Projects built for use with the Renesas GDB Server.
- Renesas Flash Programmer V1.03.00 Flash programming GUI software to allow Flash programming of the RL78/G14 internal Flash memory
- GUI to be run with the main demonstration programs
- Source code for the demonstration and debugger programs

The e<sup>2</sup> studio work environment and the Renesas Flash Programmer V1.03.00 Flash programming GUI must be installed on your PC. For detailed installation hints, refer to the following chapters and to the corresponding documentation of the e<sup>2</sup> studio for RL78 and Renesas Flash Programmer V1.03.00.

### 6.1 Sample Programs Installation

The DVD installer will automatically install the sample debugger programs and the demonstration source. The debugging project and demo source code project can be found in the following location:

C:\Workspace\RPB\RL78G14\Sample Projects\

### 6.1.1 Confirmation of USB Driver Installation

After installing the USB driver, check that the driver has been installed correctly, according to the procedure below.

Open "Device Manager" by entering:

[Start] → [Settings] → [Control Panel] → [System] → tab [Hardware]

When the *YRPBRL78G14* board is connected to the host PC, the "Renesas Electronics Starter Kit Virtual UART" (without "?" mark) should be present under the section "Ports (COM & LPT)".

The screen above shows that the COM port number is "COM13".

When you change the USB port connection, the COM port number will be changed as well.

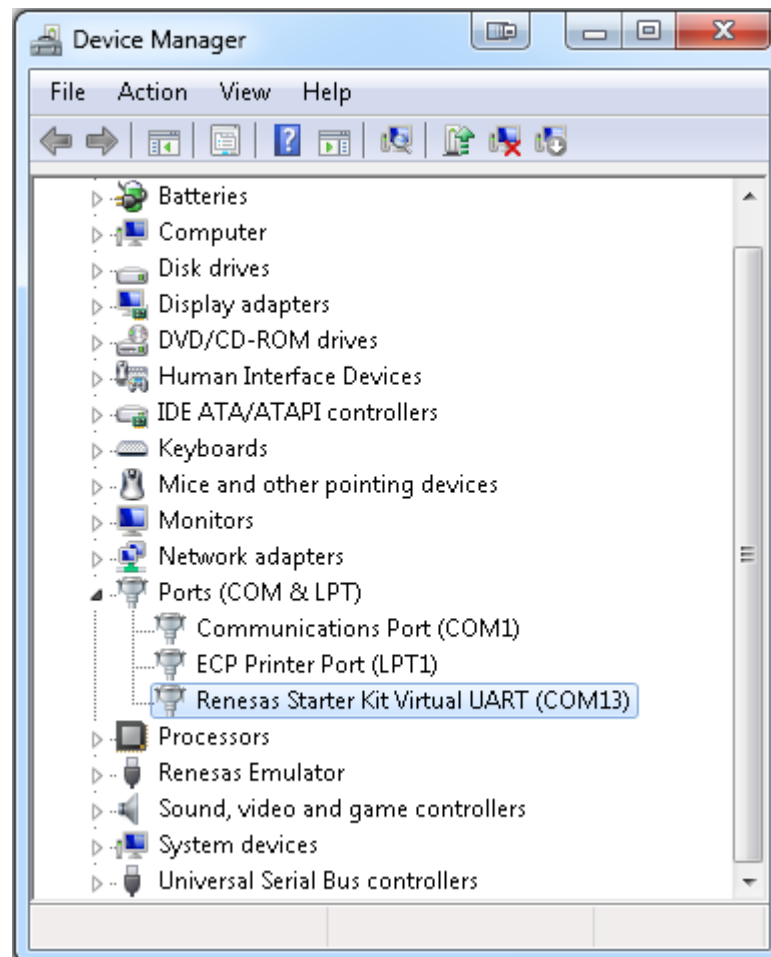

Figure 8: Device Manager

**Caution** "Hardware Modification Scan" should not be executed whilst communicating with the target device. Please refer to Chapter 9 Troubleshoot, if the driver fails to install correctly.

## Chapter 7 How to Use the Renesas Flash Programmer Software

This chapter explains the basic operations of the Renesas Flash Programmer RFP V1.03.00 GUI for programming the *YRPBRL78G14* board. This chapter covers how to start the system, execute the EP command (Erase, Program), and program the target RL78/G14 device. To use the Renesas Flash Programmer, you must connect the *YRPBRL78G14* to an E1 emulator (not included).

The conditions of the series of operations described in this chapter are as follows:

<b>Hardware Configuration of YRPBRL78G14</b>	Board	:	YRPBRL78G14
	CPU	:	RL78/G14
	Target Device	:	R5F104LE
	Voltage level	:	5V

A binary file can be generated by compiling the 'GUI Demo Source Code' project in e<sup>2</sup> studio (see chapter 7.1).

**<1> Installing the RFP V1.03.00 GUI** Install the Flash Programmer V1.03.00 GUI software on the host machine you are using, by referring to **Chapter 6 – Software Installation** (if the software has not been installed yet).

Fit a 0.1" pitch 2 row, 7 way pin header to the E1 debug header (see figure below).



**E1 Debug Header**

**Figure 9: E1 Debug Header**

Connect an E1 emulator to the *YRPBRL78G14*, and the E1 emulator to the host PC via USB cable (see figure below).

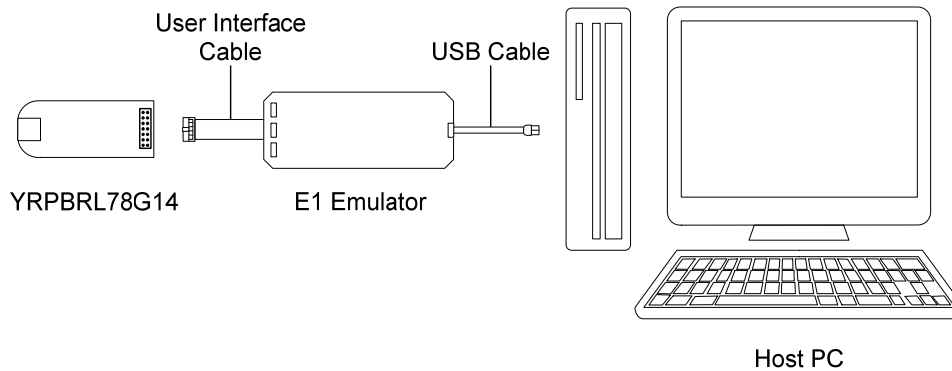

Figure 23: *YRPBRL78G14* E1 Connection Diagram

Start the Renesas Flash Programmer V1.03.00 GUI from the start menu:  
 [Start] → [All Programs] → [Renesas] → [Renesas Flash Programmer V1.03.00]

Figure 24: Flash Programmer Start-up Screen

(5.1) Select [Create new workspace] and click button **Next**.

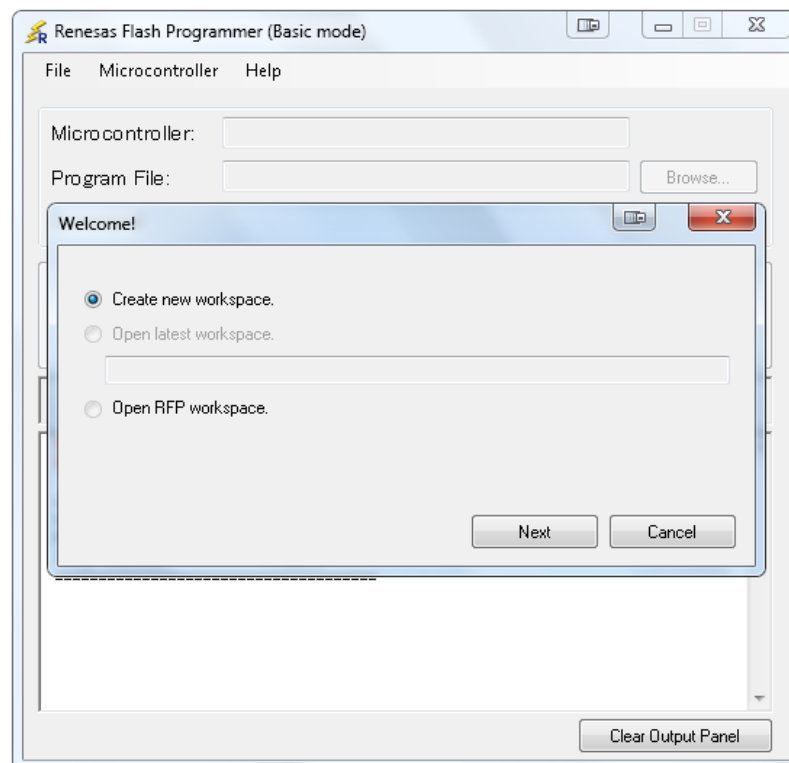

Figure 10: « RFP Welcome » Dialog Box

(5.2) from the menu select [Microcontroller] → [RL78]. A list off all supported devices will appear in the target Microcontroller. Select [R5F104LE].

(5.3) Give the workspace and the project a name. The RFP V1.03.00 will by default save the workspace to the following location:

C:\Documents and Settings\User\_Name\Local Settings\Application Data\Renesas Flash Programmer\V1.03.00. with the User\_Name being your logging user name to the host. Click button **Next**

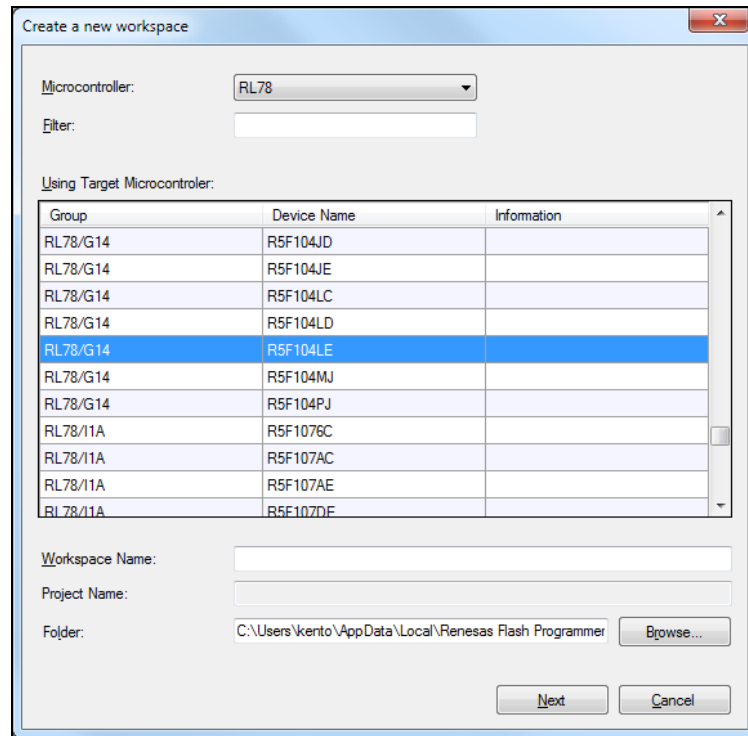

Figure 11: Device Selection

(5.4) From the “Select Tool” list box, select the communication port that matches the host machine being used. Click button **Next**.

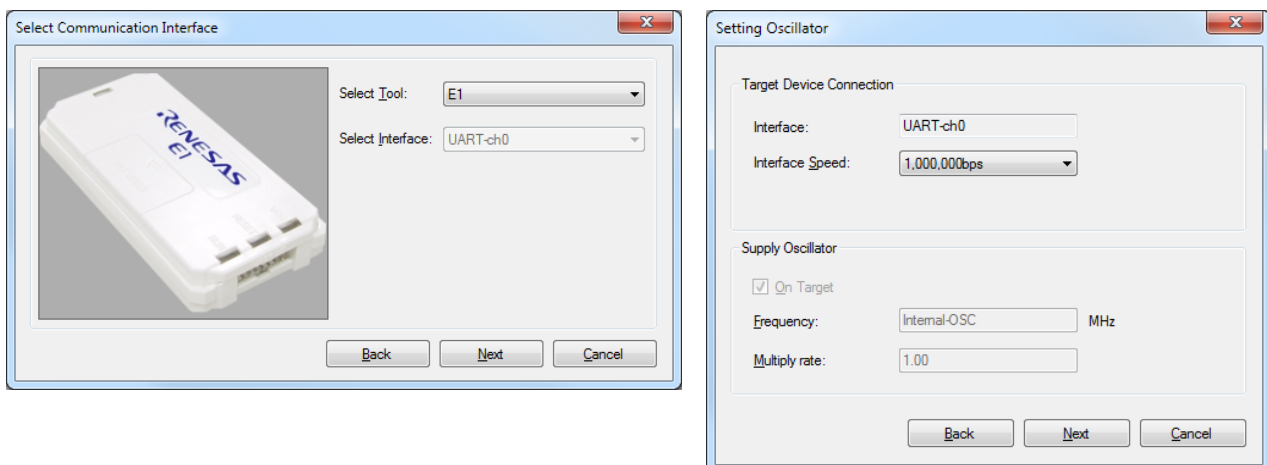
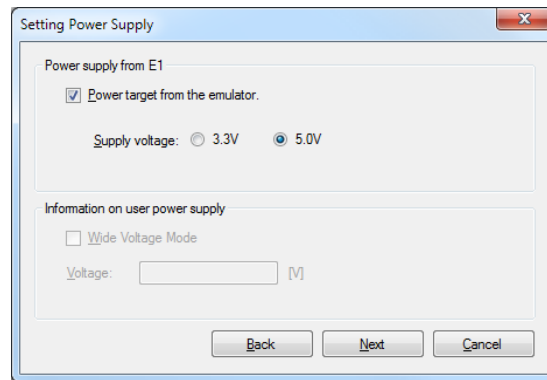

Figure 12: Port Selection



(5.5) The Setting Power Supply dialog box appears. Click button **Next**.

Figure 13: « Setting Power Supply » Dialog Box

(5.5) The following information settings window will appear with all the default parameters already set by the GUI. Click button **Complete**

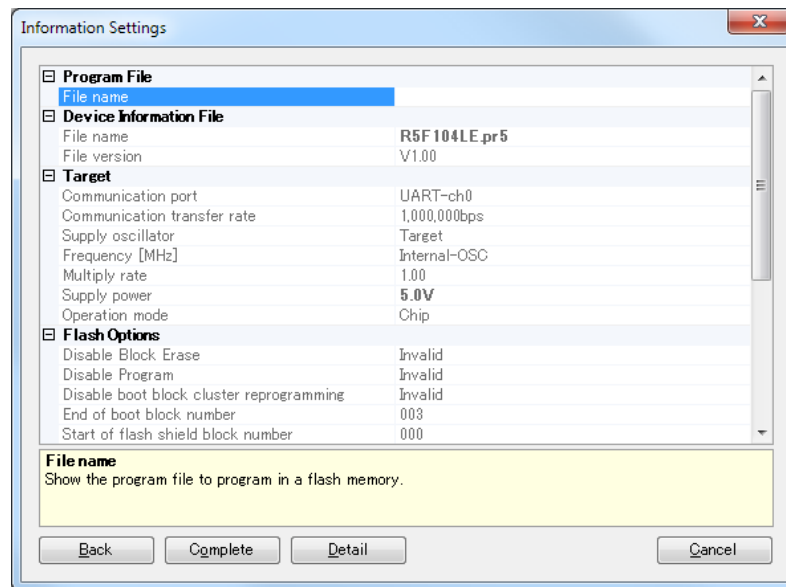

Figure 14: « Information Settings » Dialog Box

<6> **Selecting a user program** In the RFP main window click [Browse]. Select a program file to be written to the target device. In this case the YRPBRL78G14\_Stick\_Demo\_SW.mot file is used, however RFP supports .hex, .mot, .s and .rec binary file types. This can be found in the following project folder:

C:\Workspace\...\SampleProjects\GUI Demo Source Code\YRPBRL78G14\_Stick\_Demo\_SW\HardwareDebug

**Note:**

The projects found in the location C:\Workspace\...\SampleProjects should not be modified. Please refer to Section 7.1 for creating projects in e<sup>2</sup> studio based on the supplied sample projects.

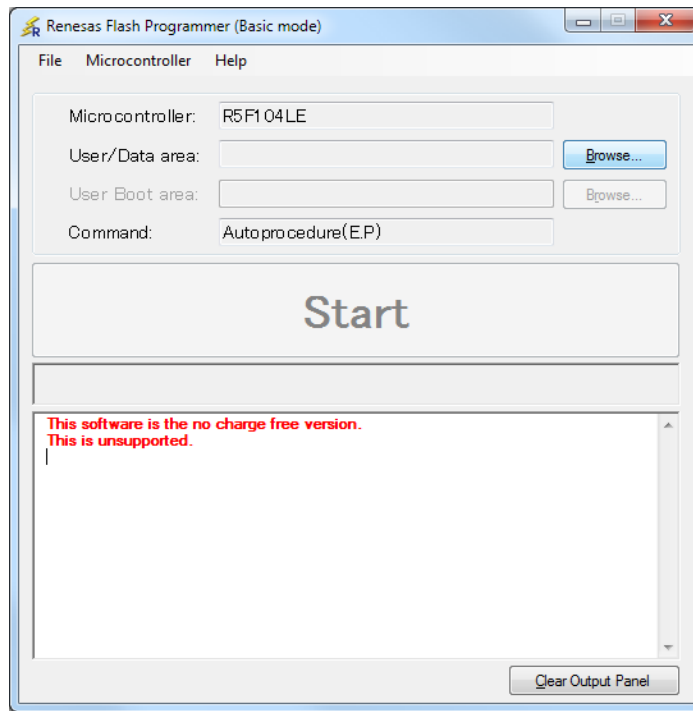

Figure 15: Selecting a user program

<7> Auto procedure (EP) command execution

Click the button **Start**.

When the Start button is Clicked, Blank Check → Erase → Program are executed sequentially for the RL78/G14 device. The result of the operation is displayed at the end.

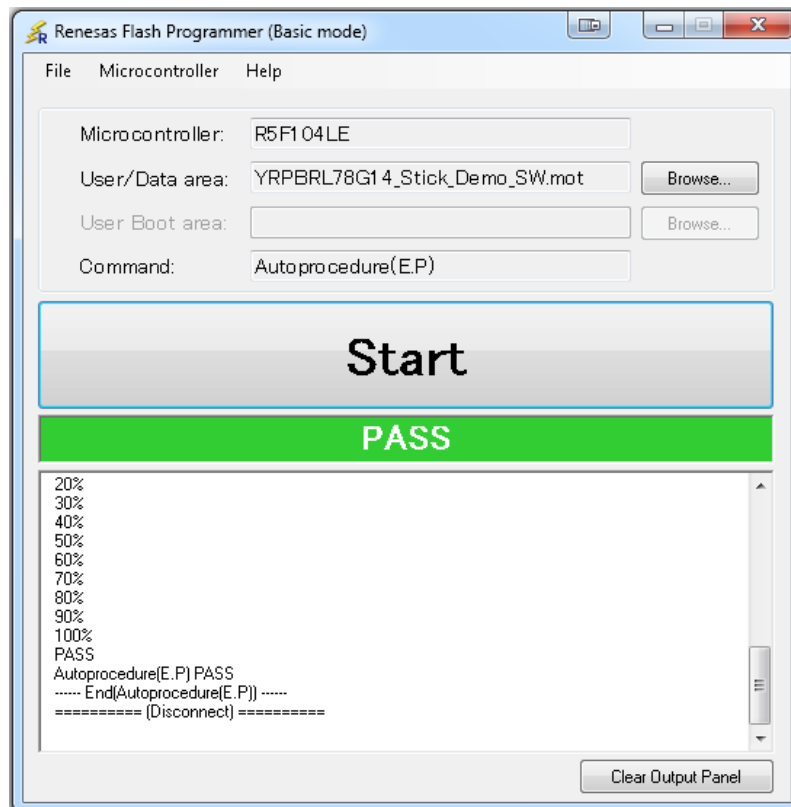

Figure 16: Flash programming

**<8> Terminating the GUI** Select [File] → [Exit] to terminate the GUI software. All settings executed are saved, so that those settings can be reused when the RFP GUI is restarted.

**<9> Execute application** Verify that CN6, CN7, CN8 and CN11 jumpers on the YRPBRL78G14 board are set for normal operation mode with the following settings:

Jumpers	Configuration
CN6	2-3
CN7	2-3
CN8	2-3
CN11	2-3

Table 10: CN6, CN7, CN8 and CN11 Configuration for Normal Operation Mode

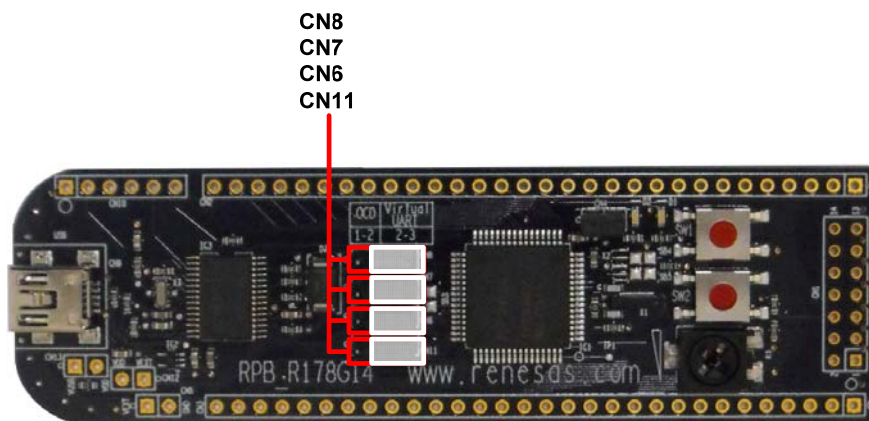

Figure 17: Board in Normal Operation Configuration

**<10> Restarting the GUI** When the Renesas Flash Programmer V1.03.00 GUI is restarted, simply reopen the latest saved workspace.

## 7.1 Debugging in e<sup>2</sup>studio

**<1> Create Workspace** The two projects provided can be debugged in e<sup>2</sup> studio using an E1 connected to CN1. The project located in the folder 'Debugging Project' does not require a demo GUI and allows the user to debug the YRPBRL78G14 hardware. The project located in the folder 'GUI Demo Source Code' cannot be fully debugged without connecting to the demo GUI. The steps provided in this section uses the 'GUI Demo Source Code' project to help the user to familiarise with the e<sup>2</sup> studio debugging environment.

Start e<sup>2</sup> studio by selecting it from Start Menu. The first dialog that will appear will be the Workspace Launcher. Click 'Browse' and select a suitable location to store your workspace, using the 'Create New Folder' option as necessary. Click 'OK'.

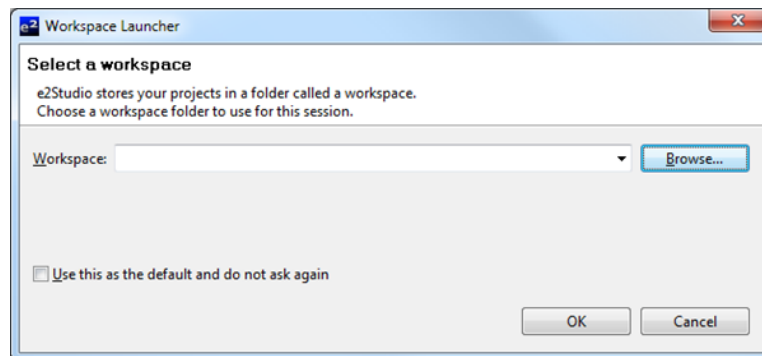

Click 'Yes' when presented with the 'Administrator Privilege' dialog.

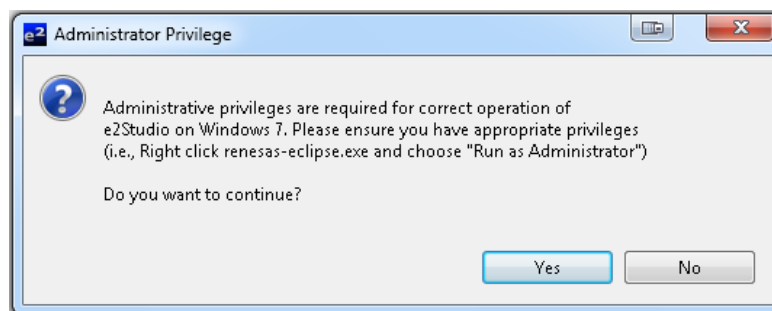

The e<sup>2</sup> studio welcome splash screen will appear. Click the 'Go to the workbench' arrow button on the far right.



**<2> Import Project** Once the e2 environment has initialised, right click in the project explorer window and click 'Import...'.

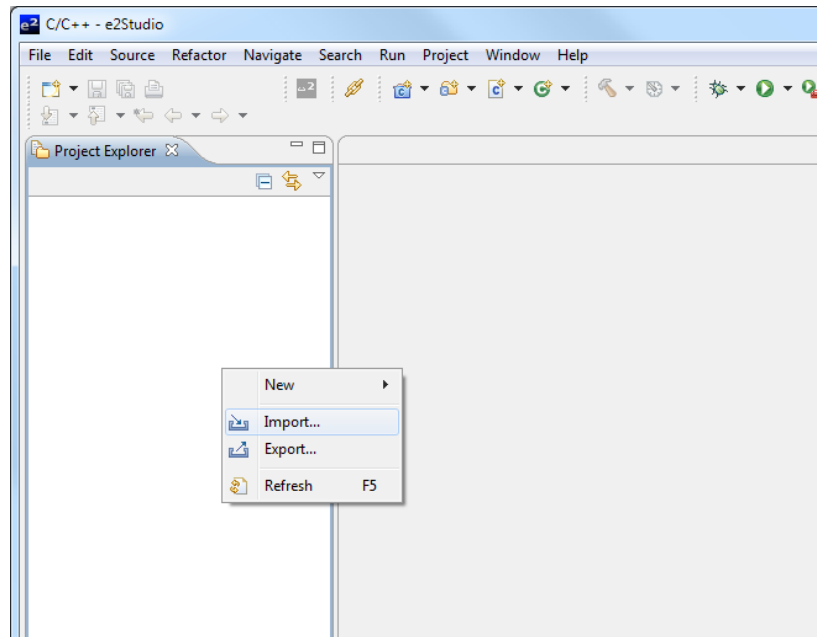

The Import dialog will now show. Expand the General folder icon, and select "Existing Projects into Workspace", then click 'Next'.

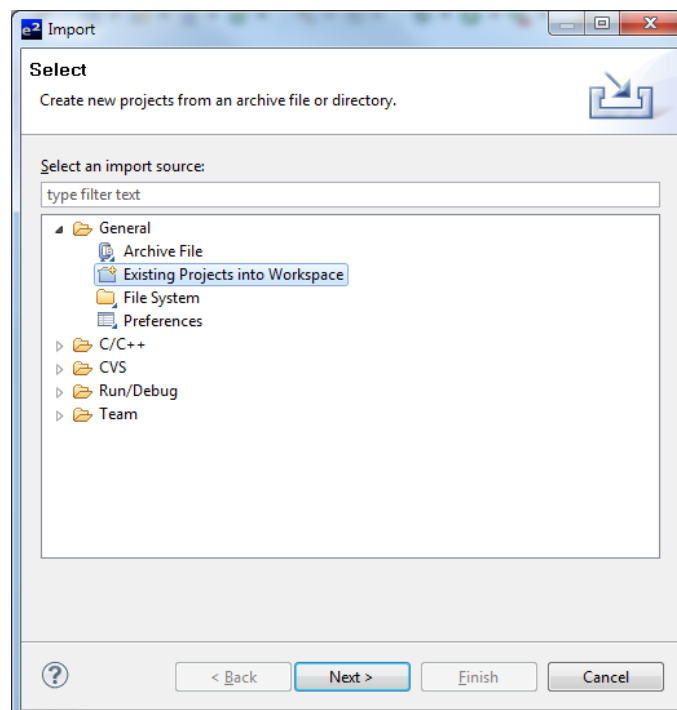

The import dialog will now allow you to specify the project to import. Click the 'Browse' button, and locate the master copy of the *YRPBRL78G14* GUI Demo Software from:

C:\Workspace\RPB\RL78G14\Sample Projects\GUI Demo Source Code

Ensure that the 'Copy projects into workspace' option is ticked, and then click 'Finish'.

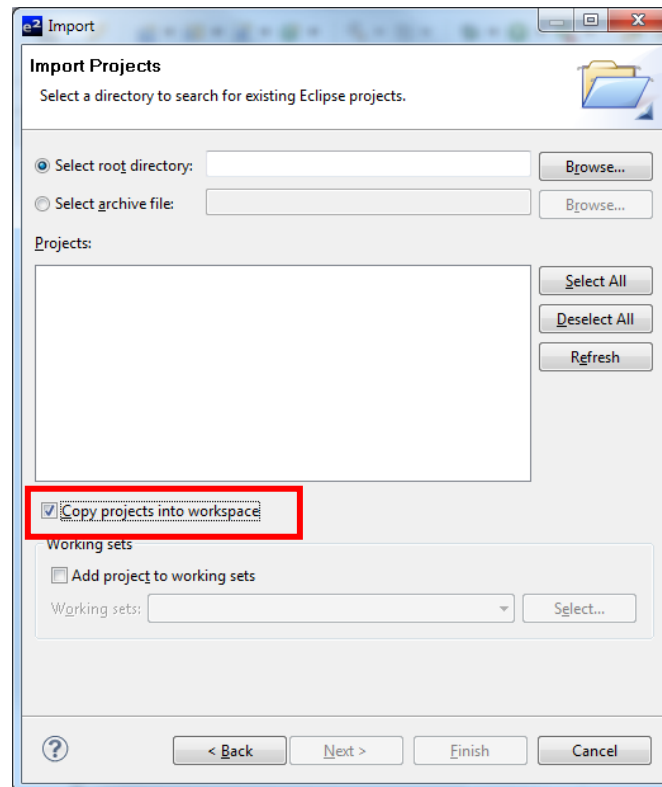

### <3> Configure Debugger Connection

Once the project has been imported, click the arrow to the right of the bug symbol to open the debugger configuration menu, and then select 'Debug Configurations'.

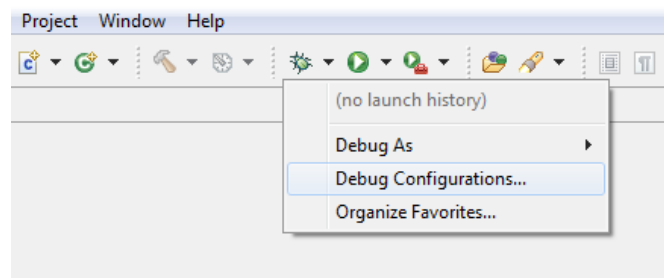

The 'Debug Configurations' dialog will appear. Click the small arrow next to 'Renesas GDB Hardware Debugging' option to reveal the pre-configured 'YRPBRL78G14\_Stick\_Demo\_SW HardwareDebug' configuration.

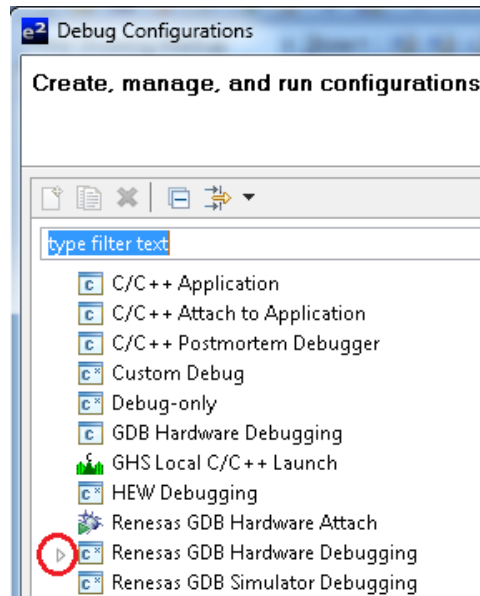

Click on the 'YRPBRL78G14\_Stick\_Demo\_SW HardwareDebug' configuration to view the configurations.

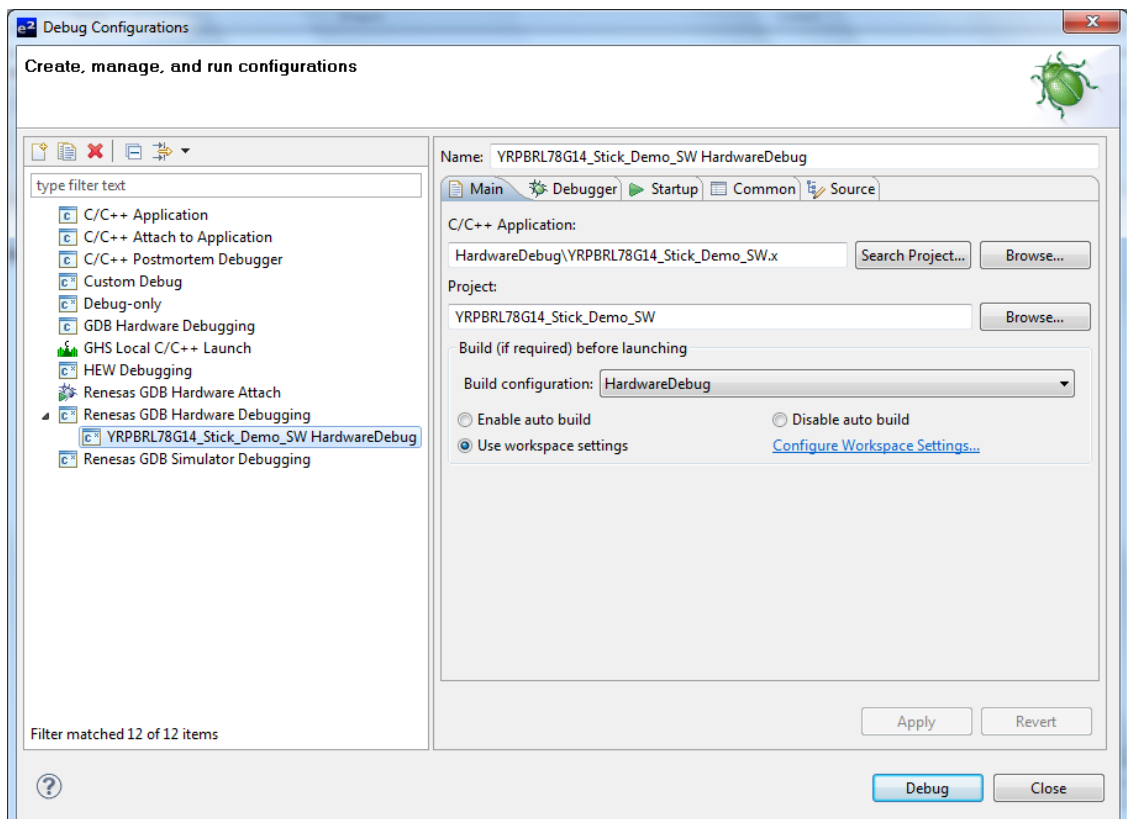

Click the 'Debugger' tab, check the settings match those shown in the image below. Make sure the 'Debug Hardware' drop down menu is set to 'E1 (RL78)', and the target device to 'R5F104LE'. The rest of the settings are as follows:

Main Clock Frequency[MHz]	Using Internal Clock
Sub Clock Frequency[kHz]	32.768
Monitor Clock	System
Communication Method	1 Line Type (TOOL0)
Power Target From The Emulator	Yes
Supply Voltage	5.0V

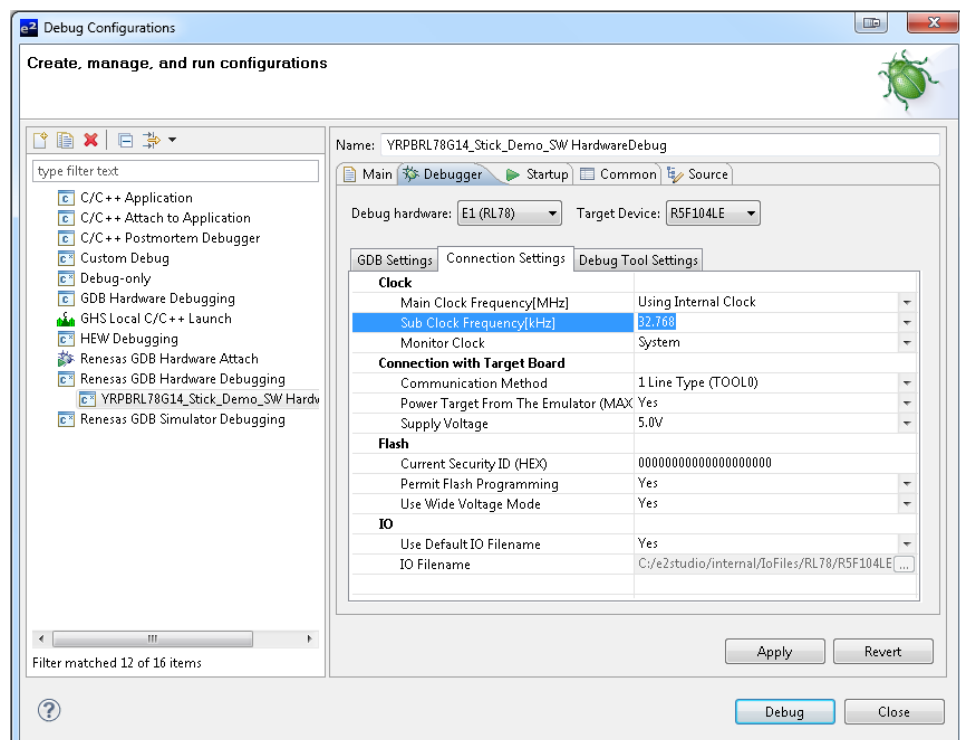

**<4> Build and Download the Sample Code** Once the debugger configuration has been verified, click 'Close' and select 'Cancel' if prompted to save the settings. Click on the small arrow next to the 'Build Configuration' button (hammer) to show the build configuration menu. Ensure that 'HardwareDebug' is selected. Clicking this will start the project build process.



Once the sample code has been built, click the bug icon to download the code to the target device and begin debugging. e<sup>2</sup> studio may show a security alert dialog, select the option that allows e2-server-gdb access. Another dialog may be shown asking to change to the 'Renesas Debugging Perspective'. Select the 'Remember my decision' tickbox to prevent this message appearing each time e<sup>2</sup> studio connects to the target device – then click 'Yes'.



<5> Running and Debugging the Sample Code

The target device should now be programmed, ready for debugging. The HardwareVector() at 0x0 tab and the debug command buttons will appear. Clicking on 'View Assembly' will open the disassembly tab.

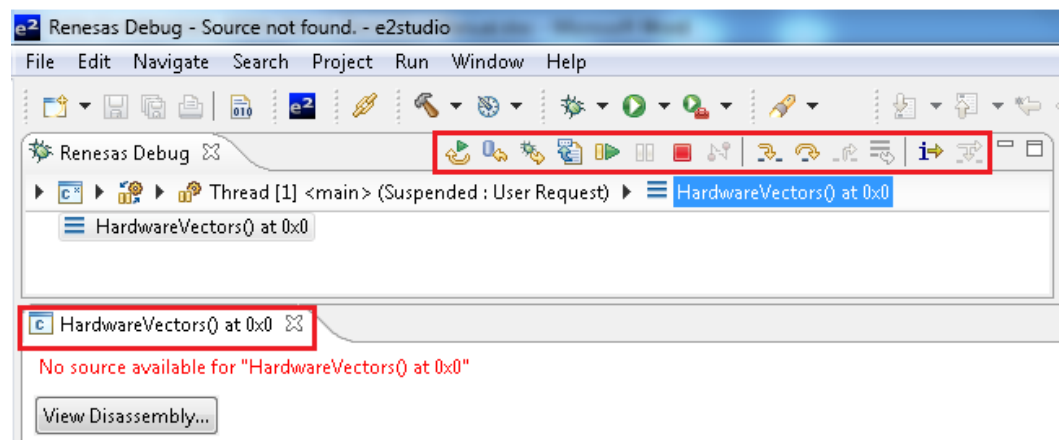

The program counter's position is indicated by the circled arrow and the instruction is also highlighted as shown below:

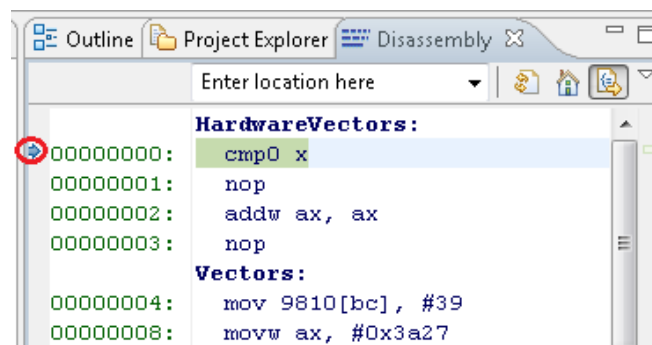

Click on the Project Explorer tab. Click on the arrow to the left of the YRPBRL78G14\_Stick\_Demo\_SW folder to expand the folder.

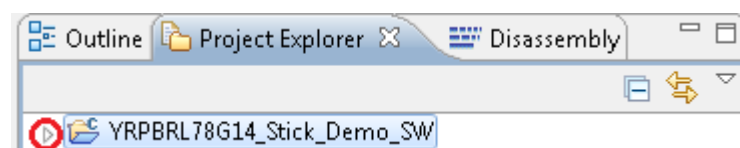

Expand the src folder to reveal the list of source files. Double click the hardware\_setup.c file to open it. Alternatively, right click on the file and select 'Open'.

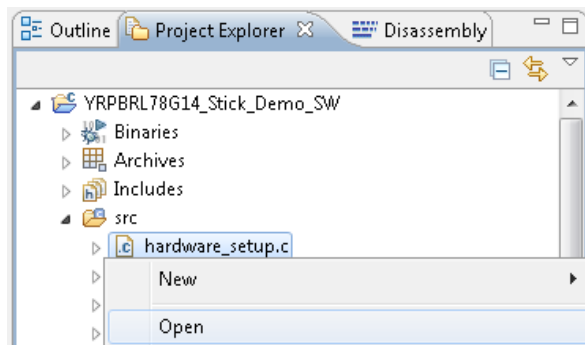

Insert a break point on the R\_Systeminit() function call inside the HardwareSetup function, by double clicking in the blue section on the left hand side of the source code window.

```

46  /*****
47  * Function Name: HardwareSetup
48  * Description  : This function calls function R_Systeminit to initialise all peripherals
49  * Arguments   : None
50  * Return Value : None
51  *****/
52  void HardwareSetup(void)
53  {
54      /* Disable global interrupts */
55      asm("DI");
56
57      /* Configure all peripherals */
58      R_Systeminit();
59
60      /* Enable global interrupts */
61      asm("EI");
62  }

```

Note:

For the HardwareSetup function to be executed, a macro named 'RELEASE' needs to be defined. This macro has been defined in Tools Settings > Compiler > Source. Defining a macro in this way ensures that it is visible to all functions in the project.

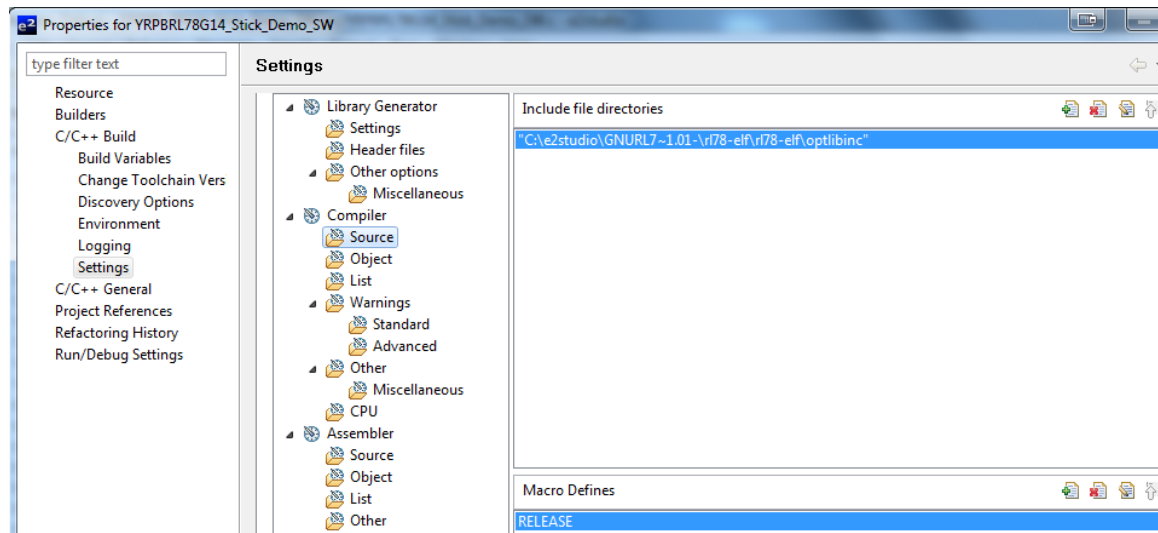

Click the 'Restart' button to restart the target device and begin code execution.

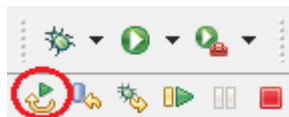

Program execution will stop at the break point. The main window will show the program counter indicator on the line of code with the break point.

```

46- /******
47  * Function Name: HardwareSetup
48  * Description  : This function calls function R_Systeminit to initialise all peripherals
49  * Arguments   : None
50  * Return Value : None
51  *****/
52- void HardwareSetup(void)
53  {
54      /* Disable global interrupts */
55      asm("DI");
56
57      /* Configure all peripherals */
58      R_Systeminit();
59
60      /* Enable global interrupts */
61      asm("EI");
62  }
    
```

Press the 'Resume' button, to run the code. It will run up to the break point, and then halt. The position of the program counter is indicated by the highlight line.

Press the 'Step In' button, to step inside the function.



The file containing the function will open, and the program counter will move to the first line of code in the function.

```

65  /*****
66  * Function Name: R_Systeminit
67  * Description  : This function initialises every macro.
68  * Arguments   : None
69  * Return Value : None
70  *****/
71  void R_Systeminit(void)
72  {
73      /* Configure port pin assignments */
74      PIOR0.pior0 = 0x00U;
75      /* Configure port pin assignments */
76      PIOR1.pior1 = 0x00U;
77      /* Read the reset source flags */
78      R_CGC_Get_ResetSource();
79      /* Configure port pins */
80      R_PORT_Create();
81      /* Configure system clocks */
82      R_CGC_Create();
83      /* Configure serial array unit 1 */
84      R_SAU1_Create();
    
```

**<6> Advanced Debug Features** The panel in the top left of the screen can be used for debugging. Click the 'Variables' tab to view all local variables currently in scope. Click 'Breakpoints' to view and edit software breakpoints, and click 'IO Registers' to view the device SFR registers.

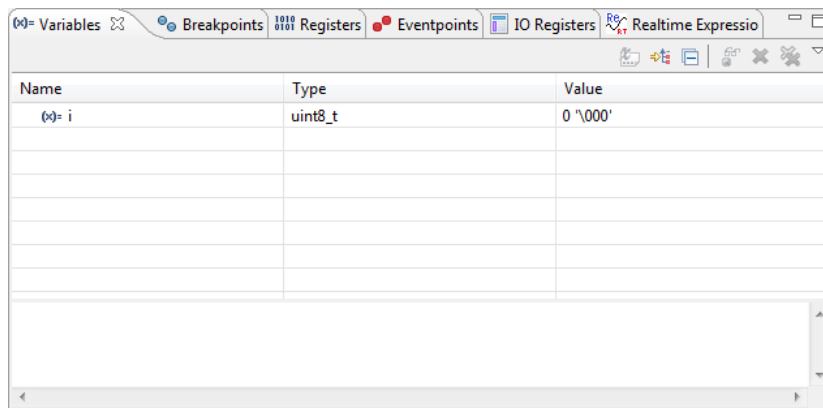

To view global variables, click 'Window' from the top menu bar and then click 'Show View' and select 'Expressions'. This will add the 'Expressions' panel to the list of tabs. Click the plus icon, and type in the name of the global variable you want to watch.

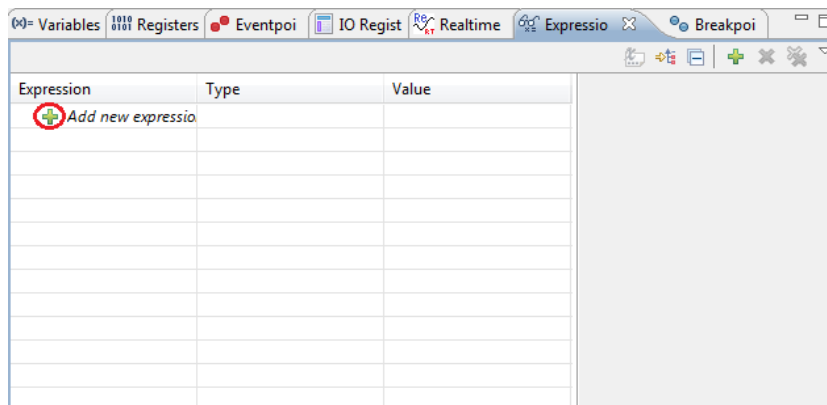

To view memory areas directly, click 'Window' from the top menu bar and then click 'Show View' and select 'Memory'. The memory window will appear docked in the bottom section of e<sup>2</sup> studio. Click the plus button to add a new memory view, and enter either a memory address location in hex or the name of a variable.

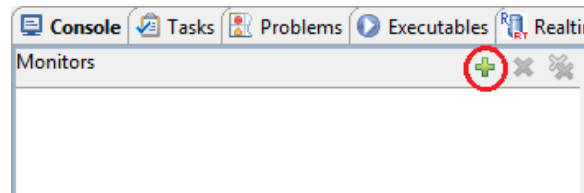

You can scroll the memory view up and down, to see adjacent memory locations.

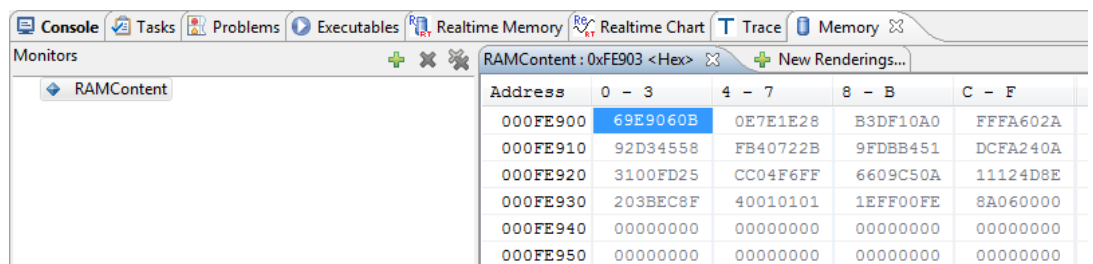

#### Note:

The projects provided with the *YRPBRL78G14* were partly created using APIs generated by Applilet; a tool used to generate source and headers files containing APIs. Source files and APIs generated by Applilet have names starting with 'r\_' and 'R\_', respectively.

The version of Applilet used in the projects provide is 'Applilet3 for RL78G14 V.1.01.01' and can be downloaded from the following website;

<http://www2.renesas.eu/products/micro/download/?oc=AP3-RL78G14-EE>

## Chapter 8 GUI Description

The RL78/G14 demonstration GUI is Windows software application that can be used to demonstrate the key operation of the 16-bit microcontroller RL78/G14 mounted on the *YRPBRL78G14* board. The demonstrations allow the user to check the on-board RTC, DTC, ELC, the memory contents (RAM), switch between the different standby modes and to check associated power consumptions, and to use the self-test functions implemented in the RL78/G14 device.

Please note that the *YRPBRL78G14* needs to be running the program supplied “**YRPBRL78G14\_Stick\_Demo\_SW.mot**” within the “GUI Demo Source Code” directory copied to the host PC during installation (This is programmed as default in manufacture).

Before connecting the *YRPBRL78G14* board, check the jumpers CN6, CN7, CN8, CN11 are configured correctly as stated in Table 1 (GUI Demonstration Mode).

After plugging the board to a free USB port make a note of the COM port assigned to the device from the device manager.

### 8.1 Running the RL78/G14 Demo

From the menu “All Programs” locate the folder “Renesas Electronics Tools → *YRPBRL78G14*” within that folder select “*YRPBRL78G14*-Demo” to run the RL78/G14 demo as shown below. It is also possible to run the demo by double clicking on the GUI demo shortcut icon on the desktop.

When the Demo GUI is started, the COM port to which the *YRPBRL78G14* board is connected should be automatically detected and selected in the “RL78/G14” tab. The GUI software should also connect to the *YRPBRL78G14* board and start automatically.

If for any reason this does not happen, please select the appropriate port number from the drop down list, and then press the “**Connect**” button on the GUI start window.

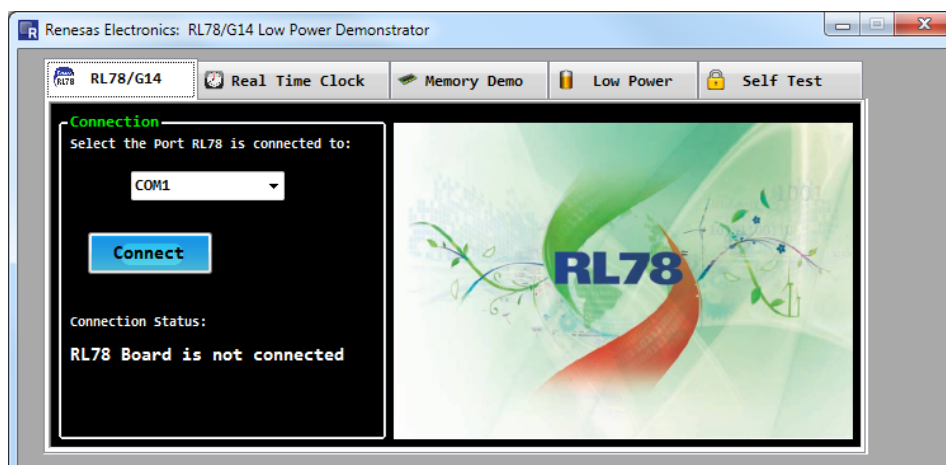

Figure 18: COM Setup

## 8.2 GUI Demo Sections

The following screenshot shows the GUI demo followed by the names and short explanations of the different sections. Please note that the lower part of the GUI (graphs and values are displayed in all of the demonstration Tabs).

The data displayed in each tab is updated every 4 to 5 seconds. Some values will not change immediately after enabling a demo test.

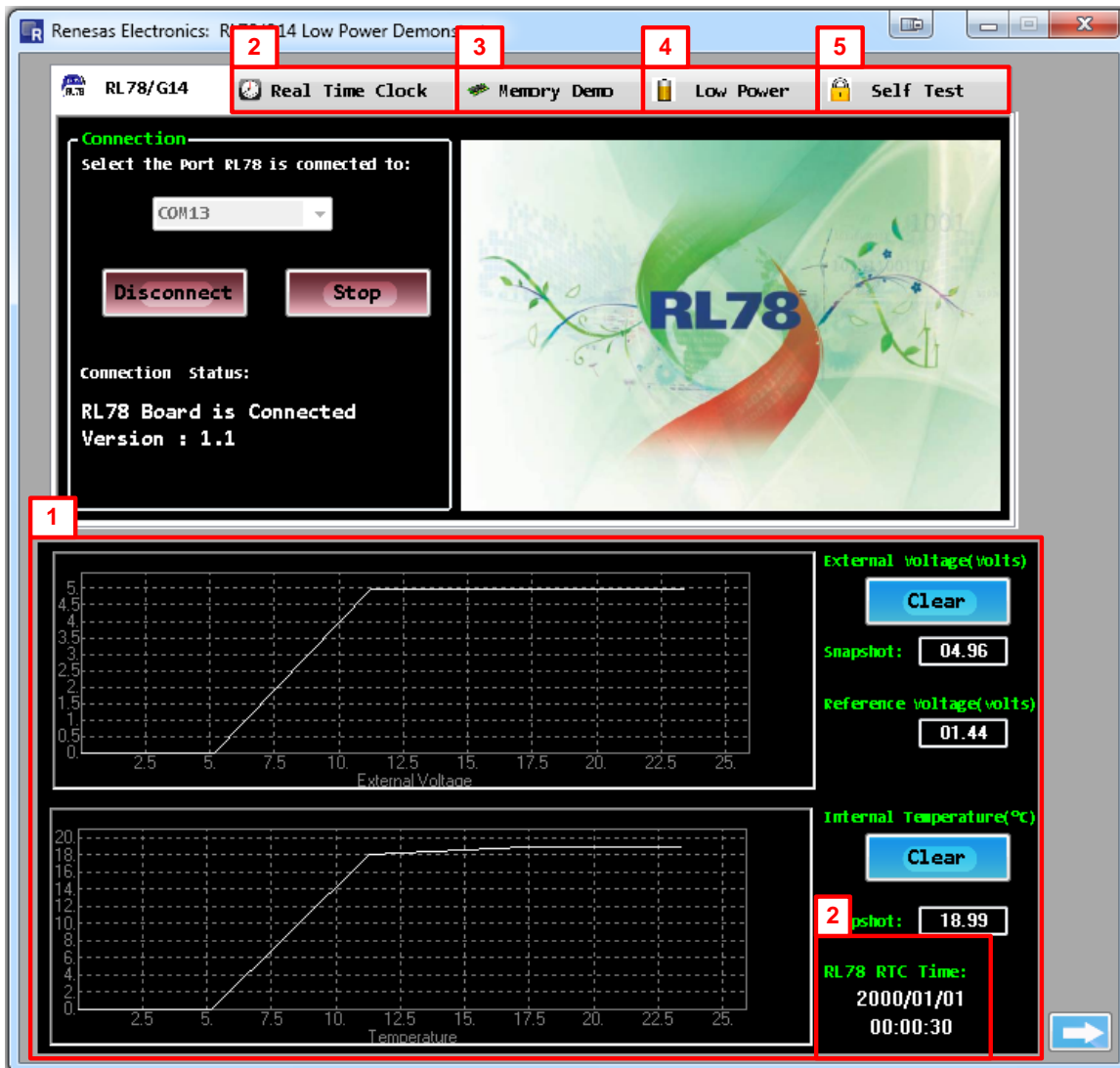

Figure 19: The RL78/G14 Demo GUI

### <1> ADC – External Voltage & Temperature Graphs

This section displays the external voltage (measured from the potentiometer on the board) and the temperature reported by the internal temperature sensor of the RL78/G14. The measurements are performed by the 10-bit ADC of the RL78/G14. The graphs can be reinitialized by clicking the “Clear” buttons on the right hand side of the window. Note that the graphs are re-scaled automatically when the “Clear” buttons are pressed, so a more detailed look of the reported values can be made.

**<2> Real Time Clock**

This section displays the date and time reported by the on-board RTC. The RL78/G14 RTC registers can be synchronized with the PC system date and time by clicking the “Sync” button. The user can also set and enable the interval interrupt and the alarm functions.

**<3> Memory – RAM Content**

This section displays the data RAM content written to by the DTC and then read from the RL78/G14 RAM variable memory. An 8 byte user area can also be written and read by the user. RAM content is not lost even when the RL78/G14 enters the lowest power mode (STOP mode) providing power is not removed from the board.

**<4> Low Power – Low Power Mode Selection:**

Three different standby modes are implemented in the RL78/G14 device, HALT mode, STOP mode and the new SNOOZE mode.

Buttons are used to switch the operational mode of the RL78/G14 to the standby mode selected. The button clicked will set the RL78 into the selected low power mode and change caption to “Release”. The RL78 will remain in the selected low power mode until button is clicked again to release the RL78/G14 to the active mode, except for the Snooze mode which requires the user to adjust the external potentiometer to exit.

Detailed explanations about each of the low power modes are provided in the section 8.6 Low Power Demonstration, please refer to it.

**<5> Self-Test Function:**

This section demonstrates the different self-test functions provided within the RL78/G14. The self-test functions are switch test, RAM and SFR guard, and system clock measurement. The ELC test is also included within this tab. The interrupt from one timer is used as the clock count source for another timer.

It is important to note that tooltips are present on every buttons to guide the user through the experience of the RL78/G14 GUI Demo, and provide useful information for a good and quick understanding of the different features and peripherals demonstrated.

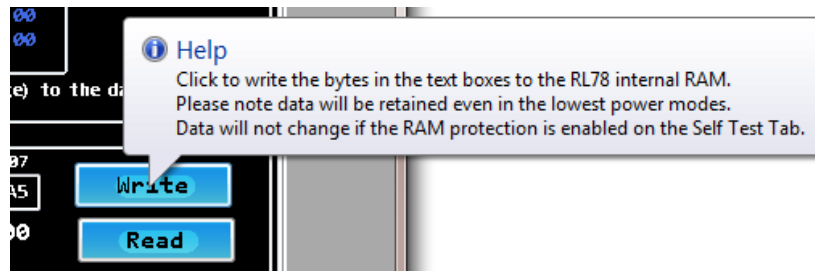

Figure 20: Tooltip Example

## 8.3 ADC Demonstration

This section of the GUI makes use of the ADC to measure and display the external voltage and the temperature using the RL78/G14 internal temperature sensor. The sensor is internal to the RL78/G14 device therefore the measured temperature might not reflect the room temperature. The internal reference voltage (TYP: 1.44V) is also displayed on the right hand side of the GUI window.

For all ADC data requests by the GUI (every 5 sec.), the internal reference voltage is measured and then used as a calculation scaling point for the external voltage (Potentiometer) and internal temperature calculations as shown in the example below:

$$\text{Ext. Voltage (V)} = \text{Ext. Voltage ADC result} \times (1.44\text{V} / \text{Int. Ref. Voltage ADC result})$$

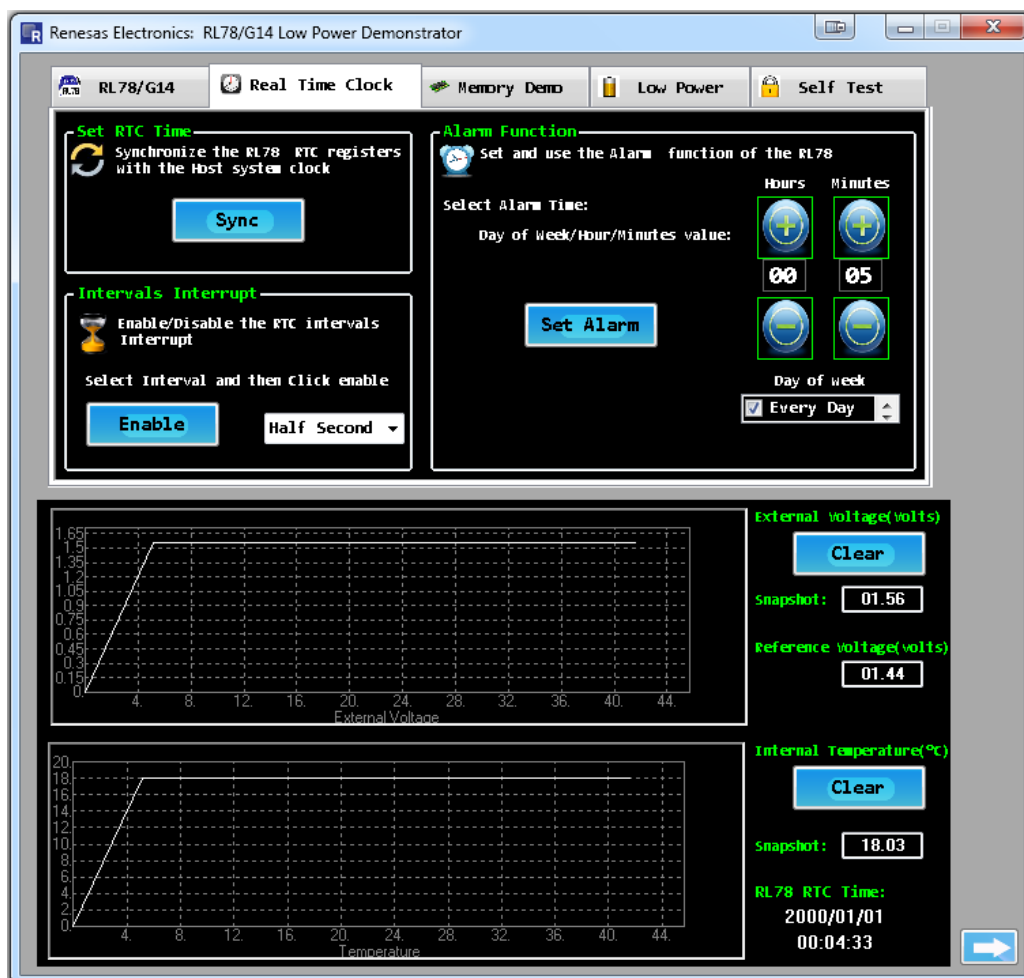

Figure 21: External Voltage & Temperature Measurements

The graphs keep a history of all the reported values from the RL78/G14. In order to clear the history and get clear readings please click the "Clear" buttons. The graphs then automatically re-scale to the displayed data values. To see the external voltage changes turn the potentiometer using the potentiometer shaft included. To increase the voltage, turn the potentiometer in a clockwise direction, to decrease the value turn the potentiometer anticlockwise. The temperature can be changed by simply touching the MCU with a finger or blowing air over the RL78 device.

## 8.4 Real Time Clock Demonstration

This section of the GUI demonstrates the capability of the RL78/G14 to implement full calendar function using the internal separate registers for seconds, minutes, hours, days, days of the week, months and years. For full explanation of the on-board RTC please consult the user manual of the device.

The RL78 stick sends the value of the RTC registers to the GUI every second and the values are displayed on the GUI on the right hand side of the lower window. When the board is first connected and powered, the RTC will start with a default value. When the RTC tab is selected in the GUI, the alarm values will be automatically set to the current time and date plus one minute, so that the user only has to click the “Set Alarm” button to set the alarm. Otherwise please check that alarm has a time and date in advance of the current settings. This can be done using the Days, Hours and Minutes buttons in the GUI.

The user can synchronize the on-board RTC with the time and date of the PC system by clicking the “Sync” button. To verify the operation Windows Date and Time applet can be launched to check that the values displayed by the GUI demonstration are synchronized with the PC system date and time. To allow the GUI to set the alarm after synchronisation, click on a different tab and allow a minimum of 3 seconds to pass before returning to the Real Time Clock tab.

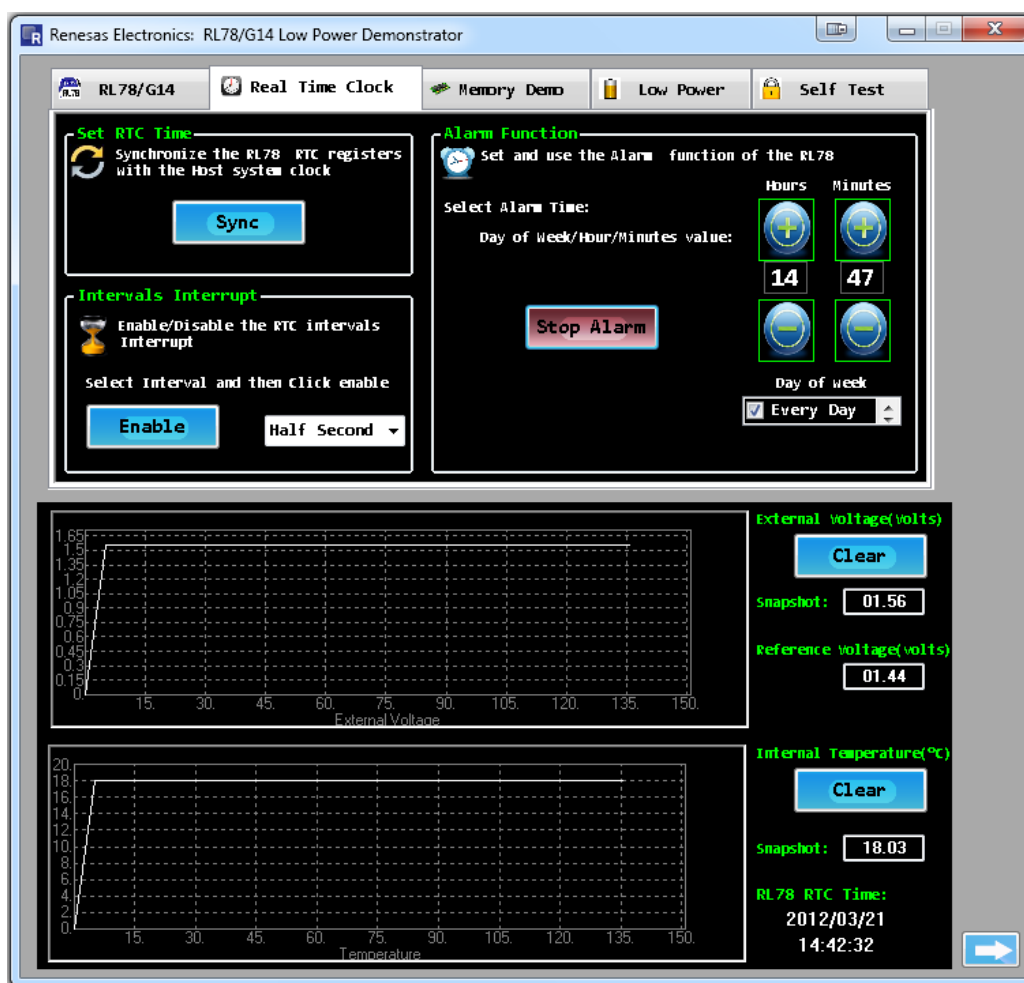

Figure 22: On-Board RTC Operation

## 8.5 Memory Demonstration

This section of the GUI demonstrates the Data Transfer Controller operation and the RAM data retention in the lowest power mode. Note the RAM window can also be used for the RAM write protection function in the “Self Test” tab as this is part of the user write protection RAM area.

In the “Memory Content” box, when the “Enable” button is pressed, the RL78/G14 enables transfers of the external voltage (2 bytes) and internal temperature’s hexadecimal values starts writing 4 bytes of data into the RAM memory for every ADC measurement (Occurring every 5 seconds).

The 4 bytes of data written are:

- o The external voltage - 2 bytes.
- o The temperature value - 2 bytes (The first byte represents the integer part and the second byte the fractional part of the value)

The active window shows the current 64 bytes of the RAM memory block being written into. The current 4 bytes written in the RAM memory appear in red colour. RAM memory content is not retained after the power is removed from the device, so that if you stop the GUI demonstration, unplug the YRPBRL78G14 board and then plug it back and restart the GUI, the RAM memory content will be re-initialised, and the window will show the data being written.

User data can be written to the internal RAM of the RL78/G14 device by entering or changing the values in the write window and clicking the “Write” button.

The data is then written to a specific location within the internal RAM of the RL78/G14. To read the data back click the “Read” button and the same internal RAM location is read by the RL78/G14 and sent back to the GUI.

The upper text field in white colour can be modified to enter random values to be written to the internal RAM. The lower text field displays the actual contents reported by the RL78/G14.

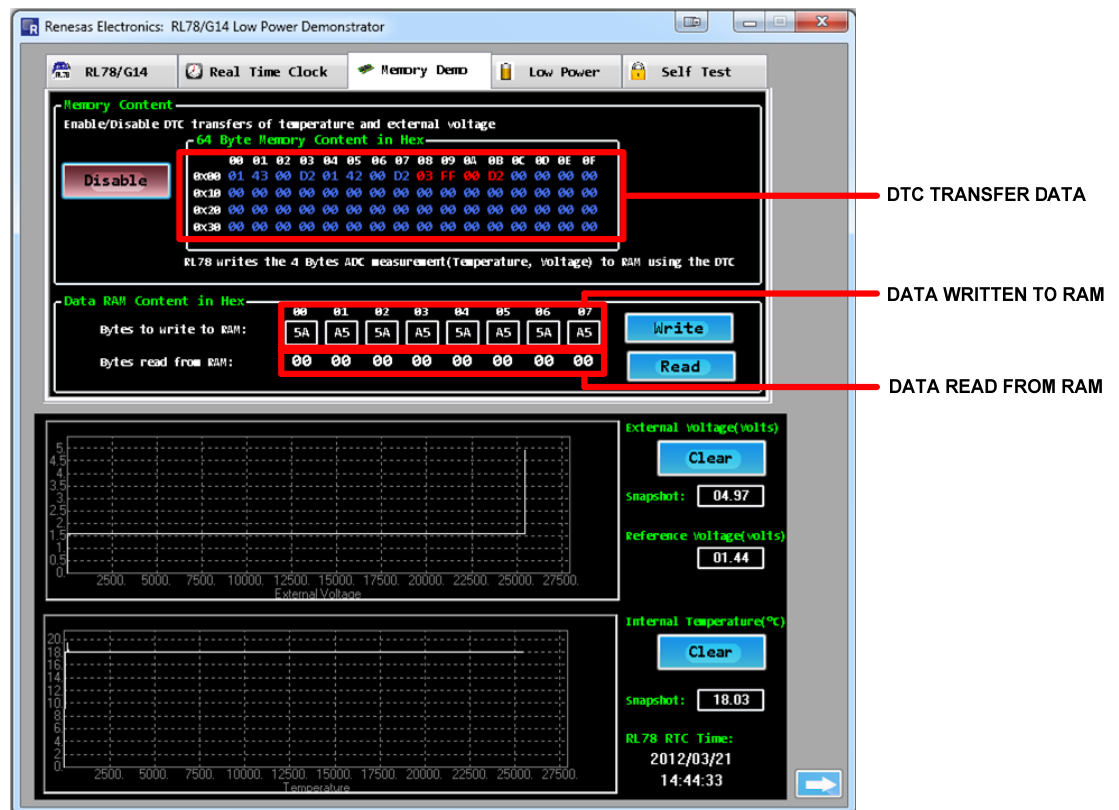

Figure 23: DTC and RAM Content

### 8.6 Low Power Demonstration

It is recommended to remove the jumper link from the connector **CN4** and replace it with the two leads of a multi-meter to be able to measure the current consumption of the RL78/G14. The following figure gives an illustration on how to connect.

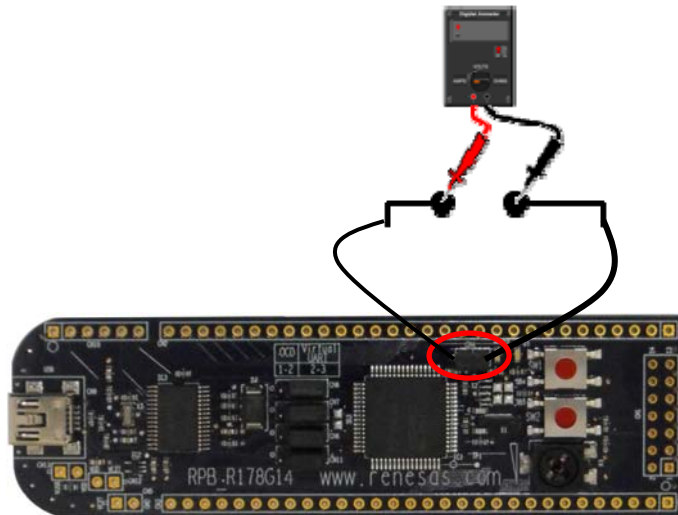

Figure 24: Multi-Meter Connection for Current Measurement

The RL78/G14 supports 3 low power modes that the GUI utilizes and demonstrates (HALT, STOP and SNOOZE). For more details on the power saving modes of the RL78/G14 please consult the device user manual. When using the low power demonstration the user clicks the appropriate button in the GUI window. The RL78/G14 will enter the selected low power mode and will remain in that state until released by the GUI again. The different low power modes supported by this GUI demonstration are explained below.

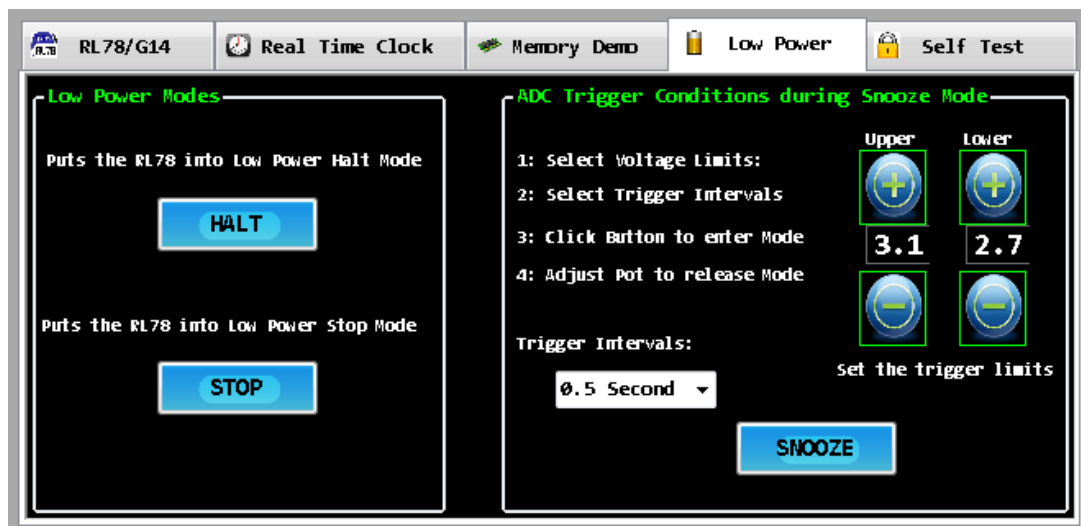

Figure 25: Low Power Mode Selection

### 8.6.1 HALT Mode

In this mode only the operating system clock to the CPU is stopped. The system clock can still be supplied to the peripherals. The total current consumption of the system can be reduced by using this mode in combination with the normal operation mode for intermittent operation.

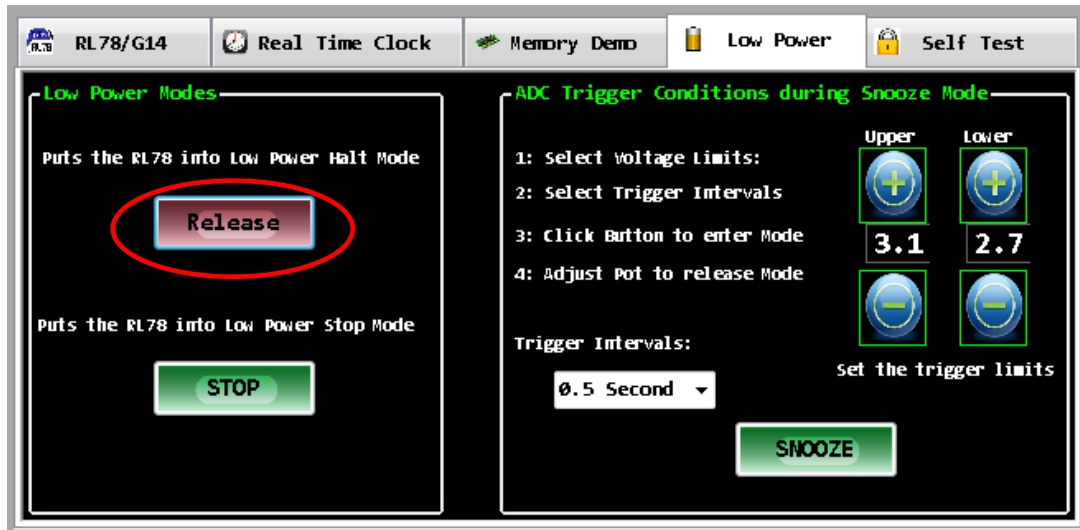

Figure 26: HALT Mode

### 8.6.2 STOP Mode

In this mode all the operations of the internal circuits except the sub-clock oscillator are stopped. This mode can reduce the power consumption to a level lower than all other modes. The RL78/G14 is still operating the RTC using the 32.768 KHz sub-system clock.

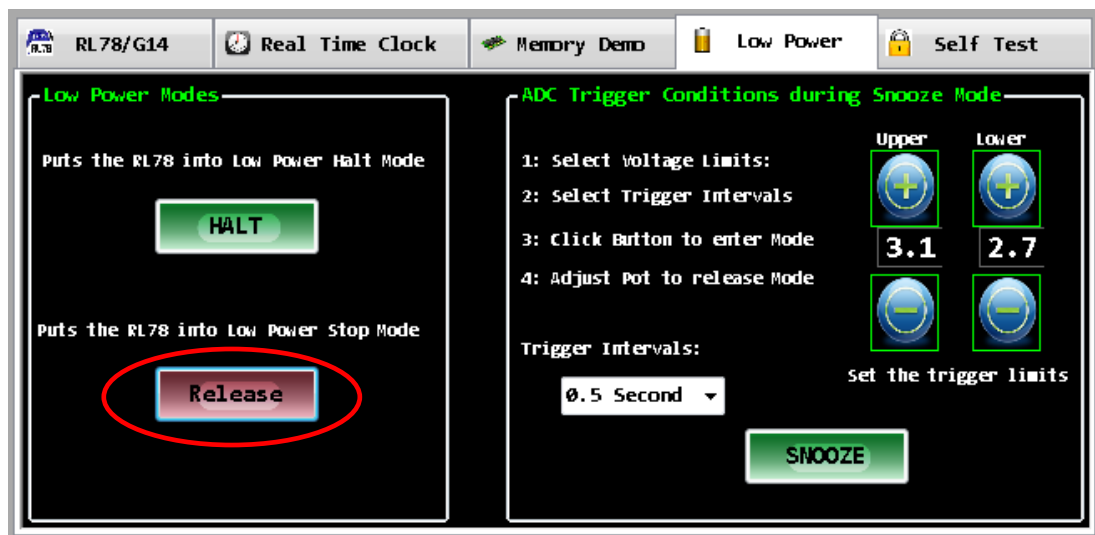

Figure 27: STOP Mode

### 8.6.3 SNOOZE Mode

The SNOOZE mode is a new mode which allows the RL78 to test for a valid “Wake Up” mode to occur, before waking the CPU. In this way the average power consumption can be reduced. The test is performed solely in hardware without having to wake the CPU each time until the valid event is met.

SNOOZE is technically part of STOP mode, but for the purposes of the demonstration the user only has to press the “SNOOZE” button to activate this demonstration.

Before activating SNOOZE mode, the user must specify the voltage window that the device is to wake up, as well as set the trigger interval of the ADC measurements. In this demonstration the RL78 has been set to wake on an external ADC voltage (Potentiometer value) that is “Outside” the specified voltage window.

SNOOZE mode alternates between STOP mode and SNOOZE mode where the system clock is supplied periodically to the ADC according to the RTC trigger intervals specified. An ADC measurement is automatically performed on the selected input channel (In our case, it is channel 2 where the potentiometer is connected). If the result of the AD conversion is outside the specified voltage range, the ADC issues an interrupt and the system clock is supplied to the CPU so that the RL78 device fully wakes up. If the ADC value is not outside the range, the CPU is not woken and the device returns to STOP mode until the next RTC trigger event.

For example, for an upper limit voltage sets to 2.9V and a lower limit voltage sets to 2.5V, the device will only wake up if you adjust the potentiometer voltage to a voltage below 2.5V (between 0V and 2.5V) or above 2.9V (between 2.9V and 5V).

As this is the only way of waking the RL78 in this mode, a window will pop up to remind the user to adjust the potentiometer.

To automatically set the limits, adjust the potentiometer, click on a different tab and allow a minimum of 3 seconds to pass before returning to the Low Power tab.

Tooltips and set-up instructions are provided in the GUI for the user to follow the instructions given in the SNOOZE mode box before clicking the “SNOOZE” button and entering this mode.

Other wake-up options are available for the RL78 device, but are not included in this demonstration. Please refer to the RL78/G14 user manual for more details.

These are:

- a. The wake up voltage can be set to occur inside the specified voltage range
- b. CSI00 or UART0 reception

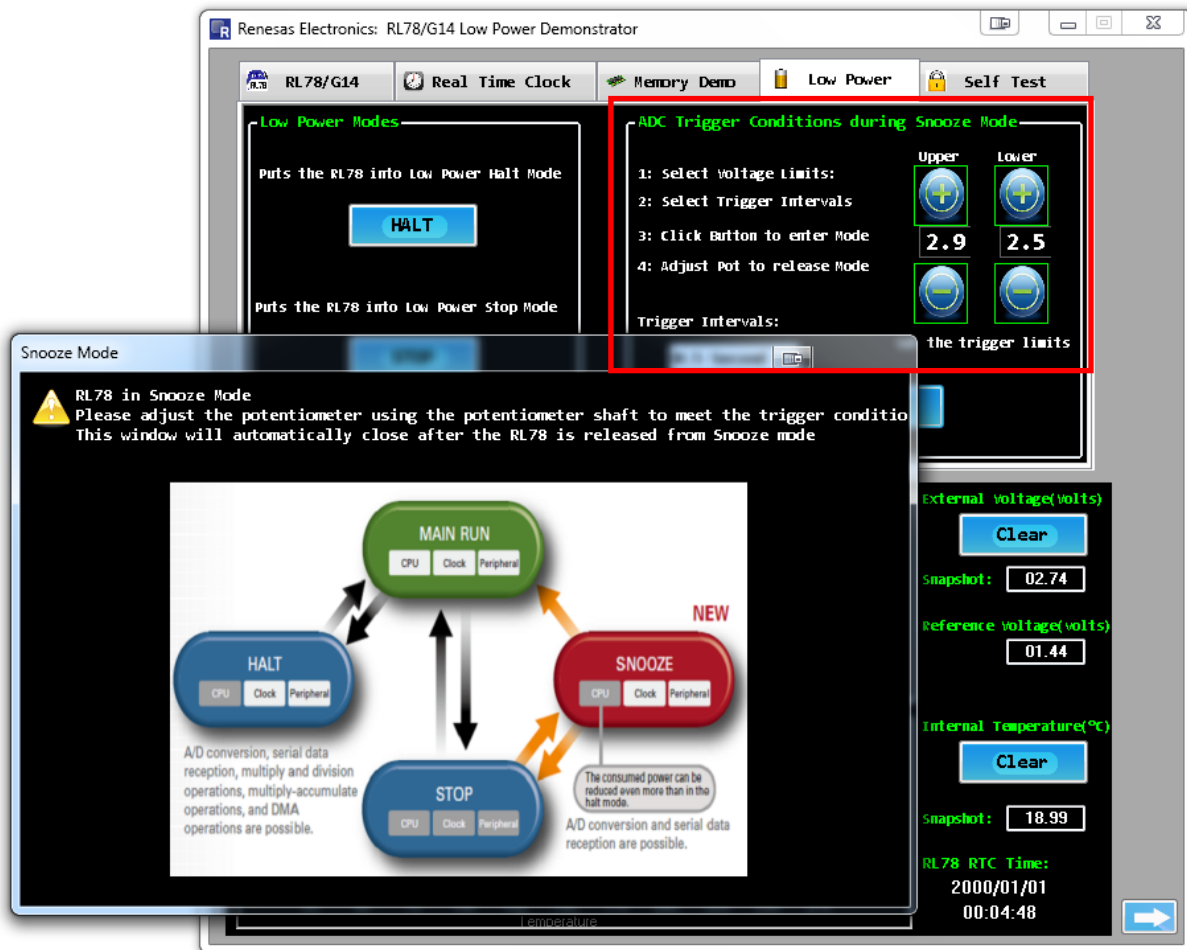

Figure 28: SNOOZE Mode

## 8.7 Self-Test Functions Demonstration

The RL78/G14 includes several new self-test and safety hardware functions, amongst these are:

1. System Clock Measurement  
This allows the measurement and monitoring of the internal system clock.
2. Switch Test  
This polls the user switches every one second.
3. Guard Test  
RAM guard function is used to protect data in the specified memory space (first 512 bytes of RAM).  
SFR guard function is used to protect data in the control registers used by the port function.
4. ELC Test  
The event link controller mutually connects (links) events output from each peripheral function. By linking events, it becomes possible to coordinate operation between peripheral functions directly without going through the CPU.

Each of them is demonstrated in the GUI. The ELC and Switch tests cannot occur concurrently. Enabling the ELC test automatically disables the Switch test.

### 1. System Clock Frequency Monitoring

The RL78/G14 also provides the ability to measure and check the system clock frequency. Click the “Enable” button, the GUI will then display the current 32 MHz internal high-speed oscillator frequency, measured by the RL78 device. The GUI will also show the minimum and maximum frequencies measured. The user can then check that the frequency is always within the desired accuracy.

The RL78 uses the external Seiko 32KHz resonator as the reference clock to measure the internal 32MHz high speed oscillator. This utilizes the special mode of the Timer Array Unit (Channel 5).

### 2. Switch Test

The switch test function is used to poll the status of the two user switches. Click the “Enable” button, and the GUI will start to actively poll the user switches every second. Pressing the switches on the YRPBRL78G14 stick will update the GUI. (Note that there may be a delay of up to 1 second between pressing a switch and it updating the GUI).

### 3. Guard Test

#### RAM Guard -

The 8 bytes of RAM memory displayed in the Memory Demo tab are located in the first 512 bytes, starting from address 0xFE00. Select the “RAM Guard” option and click the “Enable” button. Click on the Memory Demo tab, change the bytes to write to RAM then click “Write”. Attempt to read the written bytes by clicking on “Read”. The bytes read from RAM will not change. Switch to the Self-Test tab and disable RAM guard. Switch back to the Memory Demo tab and attempt to read the bytes. Notice that the bytes read from RAM matches the bytes written to RAM.

#### SFR Guard –

LED D2 is toggled every second by changing the mode of the corresponding port pin between output and input. The internal pull-up resistor is enabled so that when the port pin is set as an input, the state is high (1), that is D2 turned off. When the port pin switches to output, the output is specified as low (0) that is D2 turned on. When the SFR guard is enabled, the LED D2 stops flashing as the corresponding port mode register is protected.

When the “Disable” button is pressed the RAM or SFR returns to normal, RAM data can be written and the variables in the GUI now update and the LED starts to flash as before.

### 4. ELC

The ELC links timer TAU0 channel 3 and timer RJ0, removing the need to interrupt the CPU after clicking “Enable”. TAU0 channel 3’s interrupt signal is routed to timer RJ0 by the ELC and used as timer RJ0’s count source. The interrupt signal is the event. Switch SW2 is connected to TAU0 channel 3’s input pin. On detection of a falling edge following a switch press, TAU0 channel 3 starts counting. The count stops on detection of a rising edge resulting from the switch release, triggering an interrupt signal. The period between the switch press and release, along with the number of events is displayed.

Number of ELC Events

Guard Test

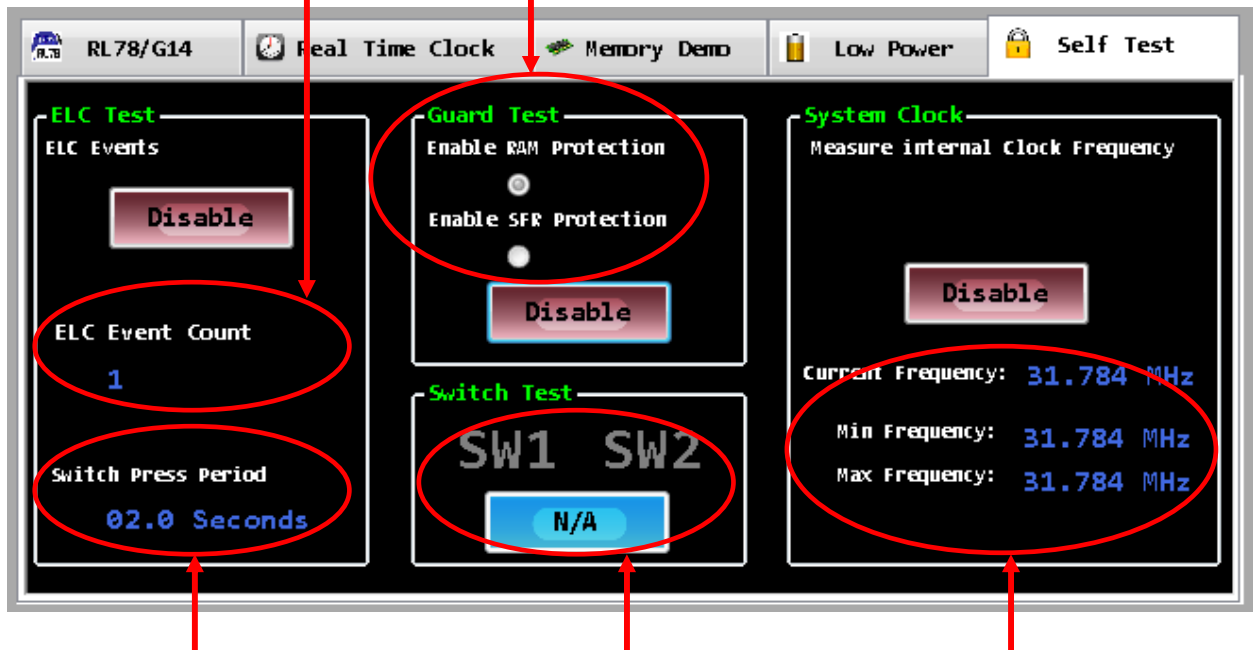

Switch Held-down Period

Switch Test

Clock Measurement

Figure 29: Self-Test Functions

## Chapter 9 Troubleshooting

- **In driver installation, recognition based on Plug and Play is disabled.**

Cause:

The USB connector may not be inserted normally into the USB port of the personal computer.

Action:

Check that the USB connector is inserted fully into the USB port of the personal computer.

Alternatively, disconnect the USB connector, and then insert the USB connector again after a while.

- **In checking by Device Manager, "USB Serial Port" or "USB High Speed Serial Converter" is not displayed. Alternatively, the "!" or "x" is prefixed**

Cause:

The USB connector may not be inserted normally into the USB port of the personal computer.

Action:

Check that the USB connector is inserted fully into the USB port of the personal computer.

Alternatively, disconnect the USB connector from the USB port, then insert the USB connector again after a while.

Cause:

The driver may not be installed correctly.

Action:

<1> When this product is connected to the personal computer, right-click the driver marked with "!" or "x".

Click  when displayed.

<2> On Device Manager, execute [Hardware Modification Scan].

<3> Install the driver again with Plug and Play.

Cause:

The device may not be recognized (in the case of connection with the USB hub).

Action:

Try the following:

- Disconnect the USB connector, then insert the USB connector again.
- Connect the USB connector to another port of the USB hub.

If the same symptom occurs, do not use the USB hub, but directly connect the connector to the USB port of the personal computer.

- **When this product is connected with a personal computer, the "Add New Hardware Wizard" screen is displayed**

Cause:

If the USB connector of this product is not inserted into the USB port used at the installation time but into another USB port, this product may be recognized as a new hardware item.

Action:

Install the driver by referring to **Chapter 6 - Software Installation**

Alternatively, the driver can be installed manually by following the provided guideline below.

- **Installation on Windows XP**

<1> When the YRPBRL78G14 board is connected to the host machine, the board is recognized by "Plug and Play", and the wizard for finding new hardware is started.

Select "No, not this time" and click **Next >**.



Figure 30: Found New Hardware Wizard (Windows XP)

Select “Install from a list or a specific location (Advanced)” and click **Next >**.



Figure 31: Install from a Specific Location (Windows XP)

<2> Mark “Include this location in the search” and then browse the computer to select the following directory:

C:\Program Files\Renesas\RPB\RL78G14\USB Drivers\win2k\

Click **Next >**.

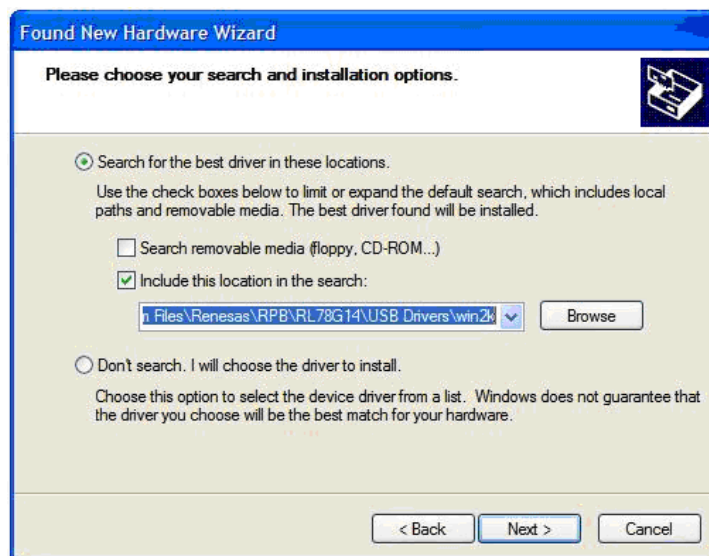

Figure 32: Search Location Specification (Windows XP)

<3> Click **Continue Anyway** to continue the installation.



Figure 33: Installation Confirmation (Windows XP)

<4> Click **Finish** to close the installation wizard.



Figure 34: USB Driver Installation Completion (Windows XP)

- **Installation on Windows Vista**

<1> When the *YRPBRL78G14* board is connected to the host machine for the first time, the board is recognized by “Plug and Play” and the “Found New Hardware” window will pop up.

Select “Locate and install driver software (recommended)”.

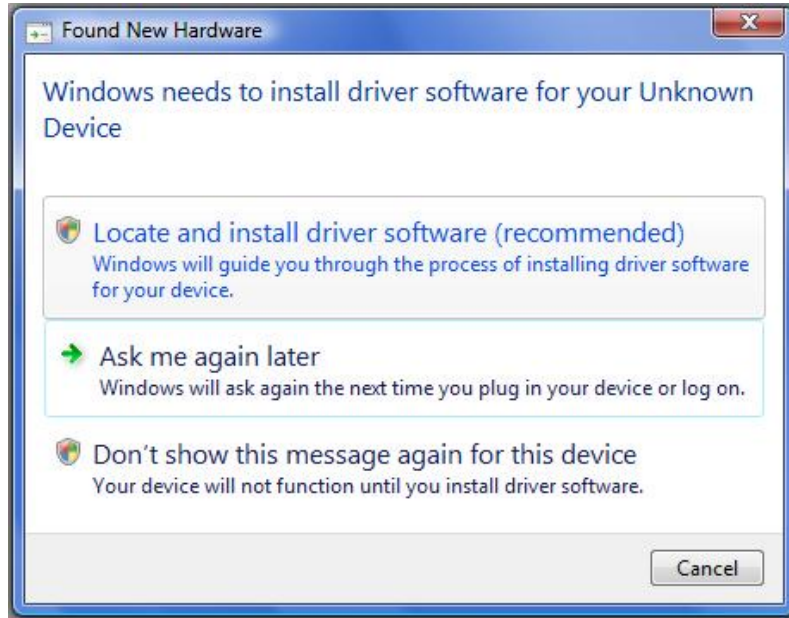

Figure 35: Found New Hardware Wizard (Windows Vista)

Then select “Browse my computer for driver software (advanced)” on the next window.

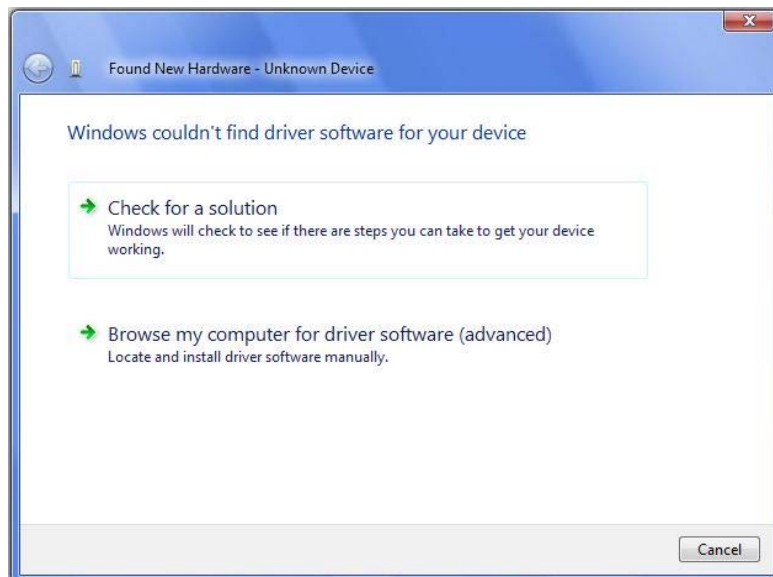

Figure 36: Install from a Specific Location (Windows Vista)

<2> Select the folder where the installer has copied the USB drivers from the DVD.

For 32-bit Operating Systems, select the following location:

C:\Program Files\Renesas\RPB\RL78G14\USB Drivers\win2k\

For 64-bit Operating Systems, select this location:

C:\Program Files\Renesas\RPB\RL78G14\USB Drivers\wlh\_amd64\

Click **Next >**

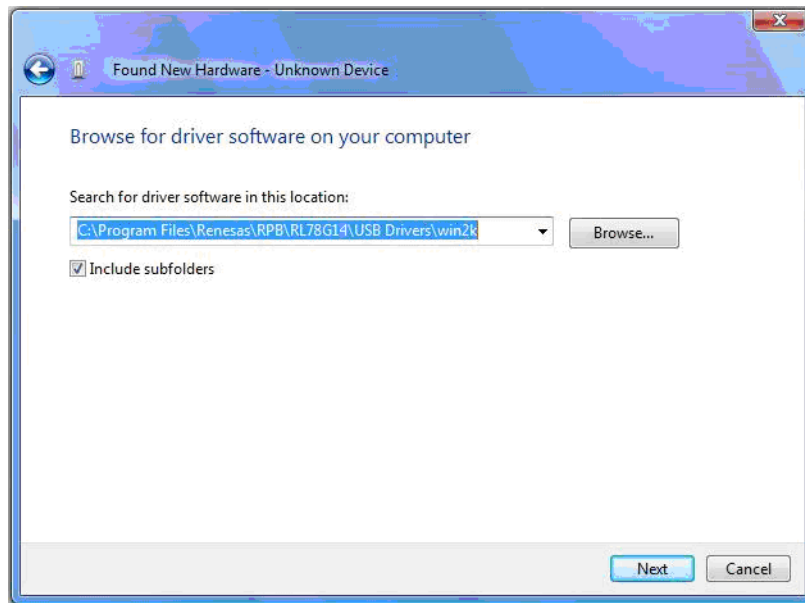

Figure 37: Search Location Specification (Windows Vista)

<3> Click **Install** when the driver has been found..

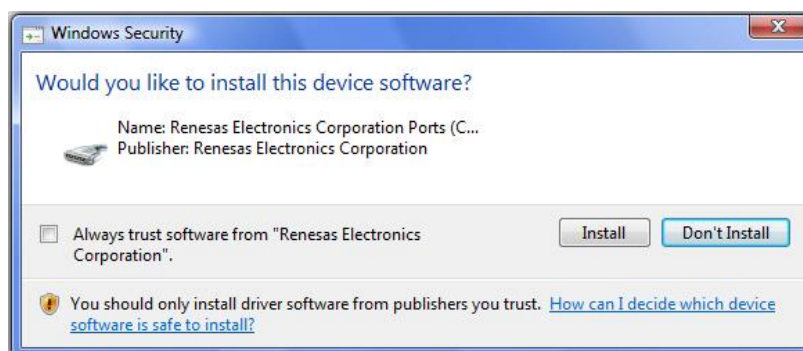

Figure 38: Installation Confirmation (Windows Vista)

<4> Click **Close** to close the installation wizard.

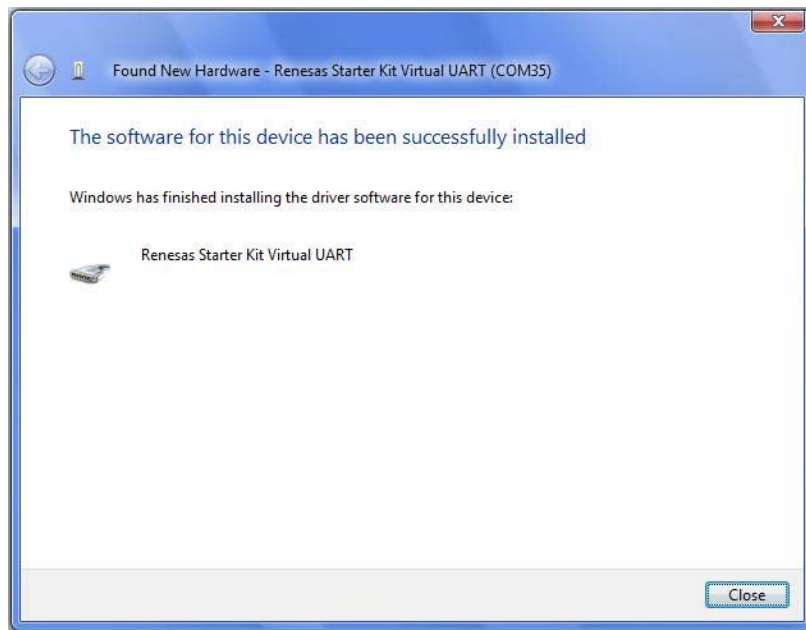

Figure 39: USB Driver Installation Completion (Windows Vista)

- **Installation on Windows 7**

<1> When the YRPBRL78G14 board is connected to the host machine, the board is recognized as an “Unknown Device” in the Device Manager. Right click on the “Unknown Device” and select “Update Driver Software...” within the Device Manager window.

Select “Browse my computer for driver software”.

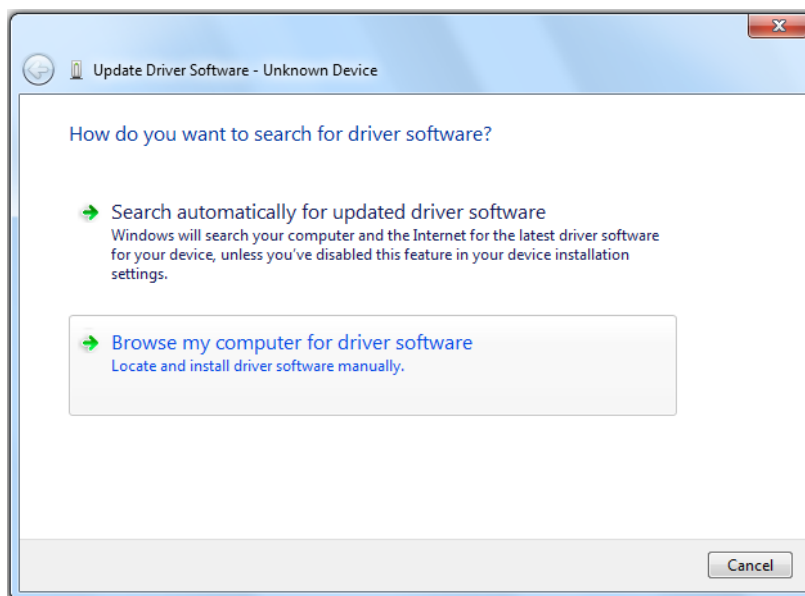

Figure 40: Update Driver Software (Windows 7)

<2> Select the folder where the installer has copied the USB drivers from the DVD.

For 32-bit Operating Systems, select the following location:

C:\Program Files\Renesas\RPB\RL78G14\USB Drivers\Win2k\

For 64-bit Operating Systems, select this location:

C:\Program Files\Renesas\RPB\RL78G14\USB Drivers\wlh\_amd64\

Click **Next >**.

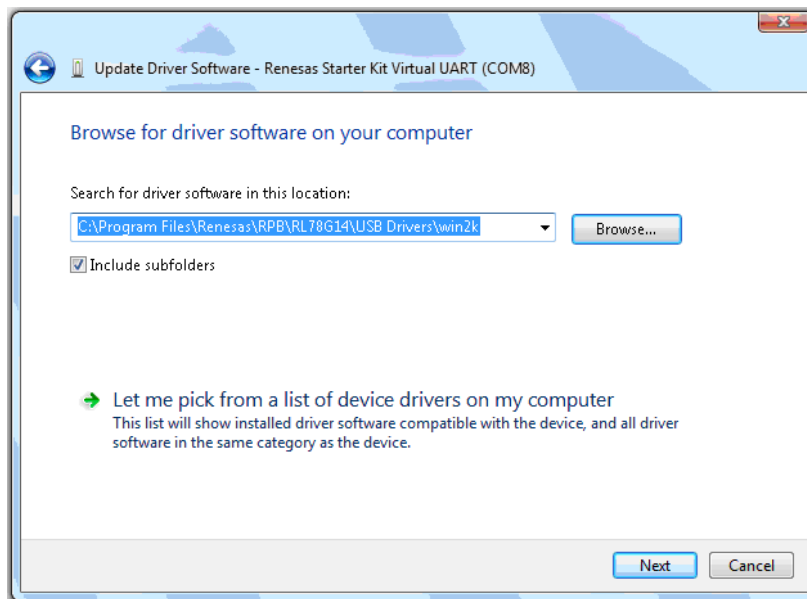

Figure 41: Search Location Specification (Windows 7)

<3> Click **Install** when the driver has been found..

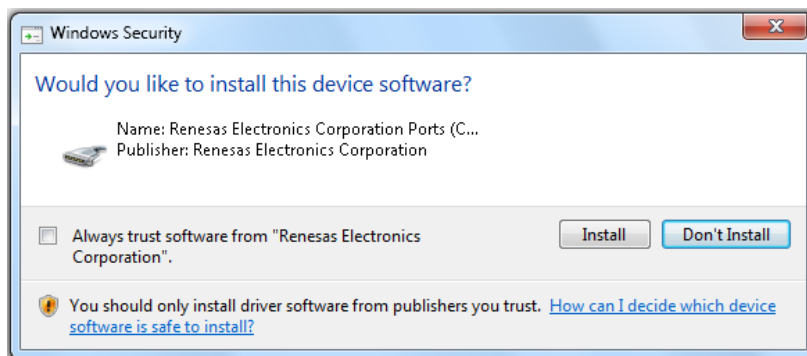

Figure 42: Installation Confirmation (Windows 7)

<4> Click **Close** to close the installation wizard.

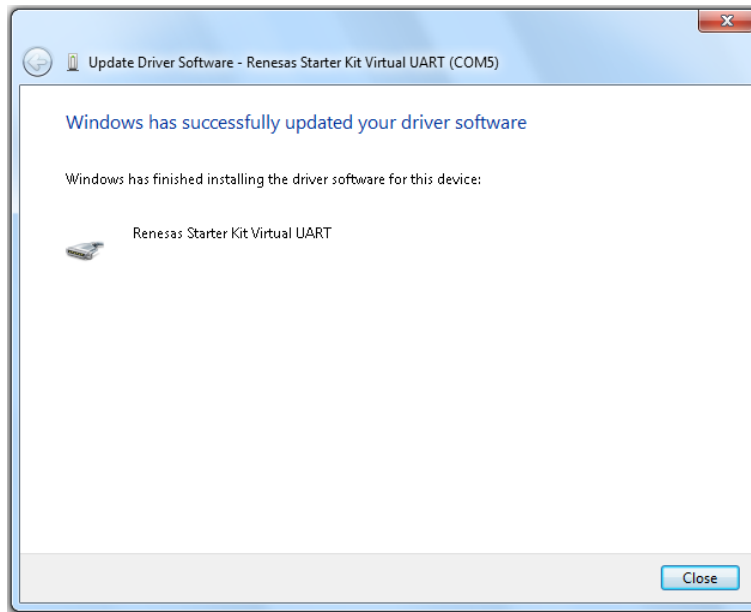

Figure 43: USB Driver Installation Completion (Windows 7)

After the manual installation, please go to

**Chapter 6.1.1 – Confirmation of USB Driver Installation.**

- **Communication with the YRPBRL78G14 is disabled**

Cause:

The driver may not be installed correctly.

Action:

Check if the USB driver is installed correctly by referring to

**Chapter 6 – Software Installation.**

Cause:

The COM port selected via the “Port list box” within device setup menu of Renesas Flash programmer may not be set correctly.

Action:

Set the port checked using Device Manager.

Cause:

The YRPBRL78G14 board is operating in GUI Demo / Virtual UART mode.

Action:

Set the board to the On-Board Debugging / Flash Programming mode.

- **Compatibility Issues with Adobe Reader 10 and Manual Navigator**

If a manual fails to open in Manual Navigator and the ‘Protected Mode’ dialog is shown, select ‘Always open with protected mode disabled’. This issue is known to occur on 64-bit Windows 7 operating systems.

- **Known e<sup>2</sup>studio Limitations**

Please refer to the release note titled D011189\_YRPBRL78G14\_Release\_Note.

- **Cygwin Heap Error**

For some 32-bit Windows 7 machines a build error may occur when using cygwin GNU compilers due to virtual memory allocation issues.

This can happen for any project and is described in the following technical note:

<http://support.code-red-tech.com/CodeRedWiki/VirtualAllocPointerNull>

# Chapter 10 Schematics

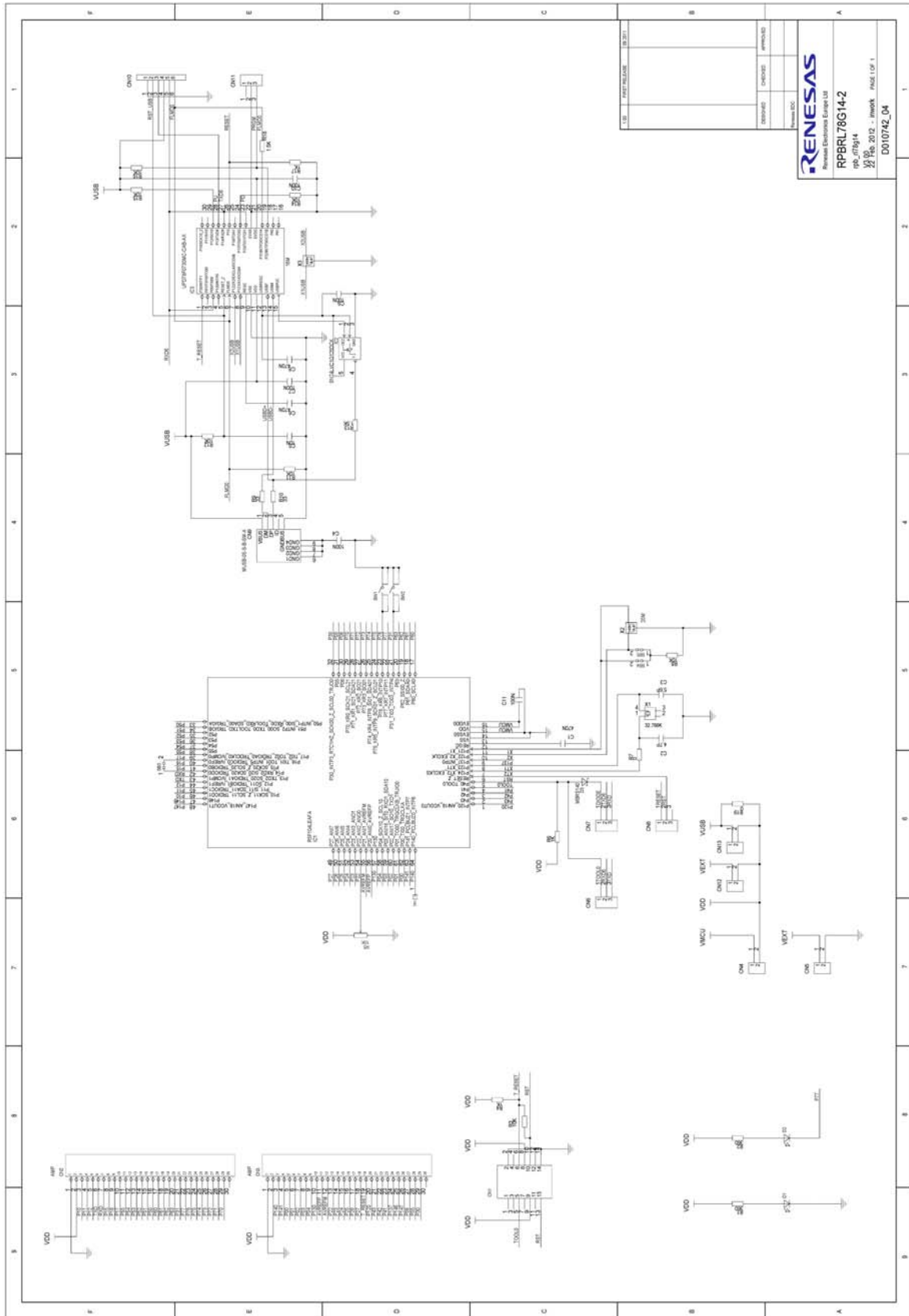

Figure 44: YRPBRL78G14 Board Schematic

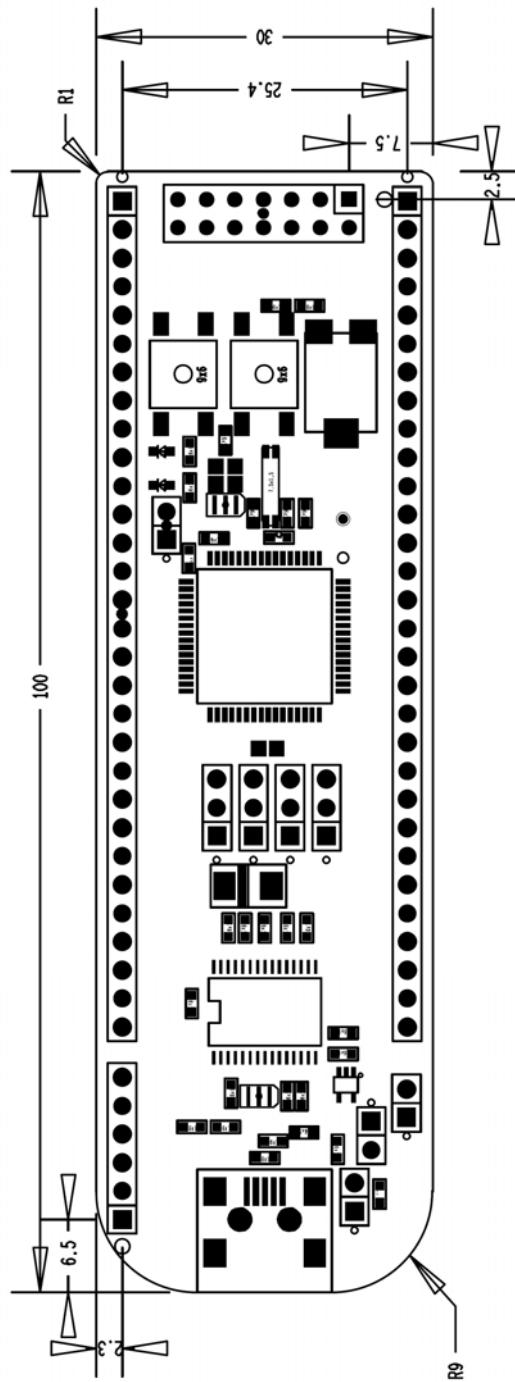

Figure 45: YRPBRL78G14 Board Assembly Drawing

## Chapter 11 Resonator from Seiko Instruments Inc

### 11.1 Features of the 32 KHz Resonator

The SSP-T7-FL is a tuning fork 32 KHz low CL crystal resonator from Seiko Instruments Inc. designed for the new low power RL78 MCU family. Microcontrollers from the RL78 family using this 32 KHz low CL resonator achieves ultra low power oscillation circuit (0.2  $\mu$ A max.) with fast start-up time (within 1 sec.), high accuracy ( $\pm 10$  sec. per month), and high efficiency (oscillation allowance up to 20%).

### 11.2 Product Name and Specifications

The different product names offered by Seiko Instruments Inc. for the RL78 microcontrollers are:

- SSP-T7-FL (SMD type low CL resonator)
- VT-200-FL (Cylinder type Low CL resonator)

The main specifications are as follows: 32.768 KHz  $\pm$  20ppm CL 4.4pF.

### 11.3 Web URL

For more information about those products, please refer to the following URL:  
[www.sii-components.com/quartz/renesas/](http://www.sii-components.com/quartz/renesas/)

## 11.4 Seiko Instruments Inc. Contact Addresses

(Japan)

Contact person name: Katsuyuki Masuko  
Quartz Crystal Sales, Electronic Components Business Unit  
Tel. number: +81-43-211-1207  
Email address: [katsuyuki.masuko@sii.co.jp](mailto:katsuyuki.masuko@sii.co.jp)  
Company name: Seiko Instruments Inc.  
Address: 8,Nakase 1-choume,Mihama-ku,CHiba-shi,  
Chiba 261-8507,Japan

(China)

Contact person name: Kensei Nozu  
Tel. number: +86-775-82462680-307  
Email address: [kensei.nozu@sii.co.jp](mailto:kensei.nozu@sii.co.jp)  
Company name: Seiko Instruments (H.K.) Ltd. Shenzhen Rep. office  
Address: 2212-2215 Diwang commercial building, Shunhin square  
5002, Shennan Est Rd., Shenzhen, Guangdong, China

(Americas)

Contact person name: Jim Schlumpberger  
Tel. number: +01-310-517-7884  
Email address: [jim.schlumpberger@siu-la.com](mailto:jim.schlumpberger@siu-la.com)  
Company name: Seiko Instruments U.S.A. Inc.  
Address: 2990 Lomita Blvd. Torrance, CA 90505, U.S.A.

(Europe)

Contact person name: Michael Bertsch  
Tel. number: +49-6102-297-303  
Email address: [michael.bertsch@seiko-instruments.de](mailto:michael.bertsch@seiko-instruments.de)  
Company name: Seiko Instruments GmbH  
Address: Siemensstr. 9, D-63263 Neu Isenburg, Germany

(Korea)

Contact person name: To be informed later  
Sunghnam Chung / Choi Kyonghoan  
Tel. number: +82-2-565-8006  
Email address: [sunghnam.chung@sii.co.jp](mailto:sunghnam.chung@sii.co.jp) / [kyonghoan.choi@sii.co.jp](mailto:kyonghoan.choi@sii.co.jp)  
Company name: Seiko Instruments Korea Inc.  
Address: #507,508, Korea City Air Terminal Bldg,  
159-6, Samsung-dong, Gangnam-gu, Seoul, 135-728 Korea

(Taiwan)

Contact person name: Shawn Yang  
Tel. number: +886 2 2516-8518 ext: 239  
Email address: [shawn.yang@sii.co.jp](mailto:shawn.yang@sii.co.jp)  
Company name: Seiko Instruments Taiwan Inc.  
Address: 6F,No.236,Sec.2,Jianguo N.Rd.,Taipei 104,Taiwan

REVISION HISTORY	RL78/G14 Stick User's Manual: Demo
------------------	------------------------------------

Rev.	Date	Description	
		Page	Summary
1.00	Mar 21, 2012	—	First Edition issued

---

RL78/G14 Stick User's Manual: Hardware

Publication Date: Rev.1.00 Mar 21, 2012

Published by: Renesas Electronics Corporation

---



## Renesas Electronics Corporation

<http://www.renesas.com>

### SALES OFFICES

Refer to "<http://www.renesas.com/>" for the latest and detailed information.

**Renesas Electronics America Inc.**

2880 Scott Boulevard Santa Clara, CA 95050-2554, U.S.A.  
Tel: +1-408-588-6000, Fax: +1-408-588-6130

**Renesas Electronics Canada Limited**

1101 Nicholson Road, Newmarket, Ontario L3Y 9C3, Canada  
Tel: +1-905-898-5441, Fax: +1-905-898-3220

**Renesas Electronics Europe Limited**

Dukes Meadow, Millboard Road, Bourne End, Buckinghamshire, SL8 5FH, U.K.  
Tel: +44-1628-585-100, Fax: +44-1628-585-900

**Renesas Electronics Europe GmbH**

Arcadiastrasse 10, 40472 Düsseldorf, Germany  
Tel: +49-211-65030, Fax: +49-211-6503-1327

**Renesas Electronics (China) Co., Ltd.**

7th Floor, Quantum Plaza, No.27 ZhiChunLu Haidian District, Beijing 100083, P.R.China  
Tel: +86-10-8235-1155, Fax: +86-10-8235-7679

**Renesas Electronics (Shanghai) Co., Ltd.**

Unit 204, 205, AZIA Center, No.1233 Lujiazui Ring Rd., Pudong District, Shanghai 200120, China  
Tel: +86-21-5877-1818, Fax: +86-21-6887-7858 / -7898

**Renesas Electronics Hong Kong Limited**

Unit 1601-1613, 16/F., Tower 2, Grand Century Place, 193 Prince Edward Road West, Mongkok, Kowloon, Hong Kong  
Tel: +852-2886-9318, Fax: +852 2886-9022/9044

**Renesas Electronics Taiwan Co., Ltd.**

7F, No. 363 Fu Shing North Road Taipei, Taiwan  
Tel: +886-2-8175-9600, Fax: +886 2-8175-9670

**Renesas Electronics Singapore Pte. Ltd.**

1 harbourFront Avenue, #06-10, Keppel Bay Tower, Singapore 098632  
Tel: +65-6213-0200, Fax: +65-6278-8001

**Renesas Electronics Malaysia Sdn.Bhd.**

Unit 906, Block B, Menara Amcorp, Amcorp Trade Centre, No. 18, Jln Persiaran Barat, 46050 Petaling Jaya, Selangor Darul Ehsan, Malaysia  
Tel: +60-3-7955-9390, Fax: +60-3-7955-9510

**Renesas Electronics Korea Co., Ltd.**

11F., Samik Lavied' or Bldg., 720-2 Yeoksam-Dong, Kangnam-Ku, Seoul 135-080, Korea  
Tel: +82-2-558-3737, Fax: +82-2-558-5141

RL78/G14 Stick