S P E C F I L E

Product Number : **PT-VZ575N**

Product Name : LCD Projectors

Specifications

Main unit

Power supply		AC 120 V, 50/60 Hz (North America), AC 110 V, 60 Hz (Taiwan), AC 100–240 V, 50/60 Hz (other countries)
Power consumption		380 W (North America), 386 W (Taiwan), 386 W (other countries) 0.2 W when STANDBY MODE set to ECO*(North America), 0.2 W when STANDBY MODE set to ECO*(Taiwan), 0.4 W when STANDBY MODE set to ECO*(other countries) 14 W when STANDBY MODE set to NORMAL (18 W when a HDBaseT™ device is connected, 30 W at rated audio output while an HDBaseT™ device is connected.)
LCD panel	Panel size	16.3 mm (0.64 inches) diagonal (16:10 aspect ratio)
	Display method	Transparent LCD panel (× 3, R/G/B)
	Drive method	Active matrix method
	Pixels	2,304,000 (1,920 × 1,200) × 3, total of 6,912,000 pixels
Lens		Manual zoom (1.6×), manual focus, F 1.60–2.12, f 15.30–24.64 mm
Throw ratio		1.1–1.8:1
Lamp		270 W UHM lamp
Screen size		0.76–7.62 m (30–300 inches) diagonally, 16:10 aspect ratio
Colors		Full color (16,777,216 colors)
Brightness*2		4,800 lumens (Input signals: PC, Lamp power: Normal, Picture mode: Dynamic)
Center-to-corner uniformity*2		85%
Contrast*2		1,000:1 (full on/off, Input signals: PC, Lamp power: Normal, Picture mode: Dynamic, Iris: on)
Resolution		WUXGA 1,920 × 1,200 pixels
Scanning frequency	HDMI	480i (525i)*3, 576i (625i)*3, 480p (525p), 576p (625p), 720 (750)/60p, 720 (750)/50p, 1080 (1125)/60i, 1080 (1125)/50i, 1080 (1125)/25p, 1080 (1125)/24p, 1080 (1125)/24sF, 1080 (1125)/30p, 1080 (1125)/60p, 1080 (1125)/50p VGA (640 × 480)–WUXGA (1,920 × 1,200), VESA CVT-RB compliant dot clock: 25–162 MHz, HDCP compatible
	RGB YPbPr (YCbCr)	fH: 15–91 kHz, fV: 24–100 Hz, dot clock: 162 MHz or lower 480i (525i): fH 15.73 kHz; fV 59.94 Hz, 576i (625i): fH 15.63 kHz; fV 50 Hz, 480p (525p): fH 31.47 kHz; fV 59.94 Hz, 576p (625p): fH 31.25 kHz; fV 50 Hz, 720 (750)/60p: fH 45.00 kHz; fV 60 Hz, 720 (750)/50p: fH 37.50 kHz; fV 50 Hz, 1080 (1125)/60i: fH 33.75 kHz; fV 60 Hz, 1080 (1125)/50i: fH 28.13 kHz; fV 50 Hz, 1080 (1125)/25p: fH 28.13 kHz; fV 25 Hz, 1080 (1125)/24p: fH 27.00 kHz; fV 24 Hz, 1080 (1125)/24sF: fH 27.00 kHz; fV 48 Hz, 1080 (1125)/30p: fH 33.75 kHz; fV 30 Hz, 1080 (1125)/60p: fH 67.50 kHz; fV 60 Hz, 1080 (1125)/50p: fH 56.25 kHz; fV 50 Hz
	Video/S-Video	fH: 15.73 kHz/15.63 kHz, fV: 59.94 Hz/50 Hz [NTSC/NTSC4.43/PAL/PAL60/PAL-N/PAL-M/SECAM]
Optical axis shift		Vertical 0 – +40% from center of screen (manual), U/D ratio on top end: 17:1
Keystone correction range		Vertical: maximum ±25° (auto/manual, input: WUXGA), Horizontal: maximum ±30° (manual, input: WUXGA)
Installation		Ceiling/desk, front/rear
Built-in speaker	Size	4 cm (1-9/16 inches) (round) × 1
	Output power	10 W (monaural)

Terminals	HDMI IN	HDMI 19-pin × 2, Deep Color, HDCP compatible
	COMPUTER 1 IN	Audio signals: Linear PCM (Sampling frequency: 48 kHz/44.1 kHz/32 kHz)
	R, G, B	D-sub HD 15-pin (female) × 1
		G: 0.7 Vp-p (1.0 Vp-p for sync on G), 75 ohms;
		B, R: 0.7 Vp-p, 75 ohms;
		HD/SYNC TTL high impedance, automatic positive/negative polarity compatible
	Y, P _B (C _B), P _R (C _R)	VD TTL high impedance, automatic positive/negative polarity compatible
		Y: 1.0 Vp-p (including sync signal);
		P _B (C _B), P _R (C _R): 0.7 Vp-p, 75 ohms
	S-VIDEO	Y: 1.0 Vp-p, C: 0.286 Vp-p, 75 ohms
	COMPUTER 2 IN / 1 OUT	D-sub HD 15-pin (female) × 1, (input/output switching)
	R, G, B	G: 0.7 Vp-p (1.0 Vp-p for sync on G), 75 ohms;
		B, R: 0.7 Vp-p, 75 ohms;
		HD/SYNC TTL high impedance, automatic positive/negative polarity compatible
	Y, P _B (C _B), P _R (C _R)	VD TTL high impedance, automatic positive/negative polarity compatible
		Y: 1.0 Vp-p (including sync signal);
		P _B (C _B), P _R (C _R): 0.7 Vp-p, 75 ohms
	VIDEO IN	Pin jack × 1, 1.0 Vp-p, 75 ohms
	AUDIO IN 1	M3 (L, R) × 1, 0.5 Vrms, input impedance: 22 kilohms or more
	AUDIO IN 2 / MIC IN	M3 (L, R) × 1, 0.5 Vrms, input impedance: 22 kilohms or more
	AUDIO IN 3	Pin jack (L, R) × 1, 0.5 Vrms, input impedance: 22 kilohms or more
	AUDIO OUT	M3 (L, R) × 1 (monitor out, stereo)
		0–2.0 Vrms, variable, output impedance: 22 kilohms or less
	SERIAL IN	D-sub 9-pin (female) × 1, for external control (RS-232C compliant)
	DIGITAL LINK / LAN	RJ-45 × 1, for network connection/DIGITAL LINK, 100BASE-TX, compliant with PJLink™)
	USB A	USB type-A (for the Memory Viewer) × 1
	USB B	USB type-B (for the USB Display) × 1
Power cord length		2.0 m* (6 ft 7 in)
		*PT-VZ575ND(for India) : 3.0 m (9 ft 10 in)
Cabinet materials		Molded plastic
Dimensions (W × H × D)		389 × 125* ⁴ × 332* ⁵ mm
		(15-5/16 × 4-29/32* ⁴ × 13-1/16* ⁵ inches)
Weight* ⁶		Approx. 4.9 kg (10.8 lbs)
Operation noise* ²		30 dB (LAMP POWER: NORMAL), 29 dB (LAMP POWER: ECO)
Operating temperature		0–40 °C (32–104 °F) (altitude: less than 1200 m)
		0–30 °C (32–86 °F) (altitude: 1,200 m–2,700 m)
		* When the ambient operating temperature is 35–40 °C (95–104 °F), [Lamp Power] will switch automatically to [Eco mode].
Operating humidity		20%–80% (no condensation)
Remote control unit		
Power supply		3 V DC (R03/LR03/AAA type battery × 2)
Operation range* ⁷		Approx. 7 m (23 ft) when operated from directly in front of the signal receptor
Dimensions (W × H × D)		48 × 145 × 27 mm (1-7/8" × 5-23/32" × 1/16")
Weight		Approx. 102g (3.60 ozs.) (including batteries)
Wireless LAN		
Standard		IEEE 802.11a/b/g/n
Modulation		DBPSK, DQPSK, CCK, BPSK, QPSK, 16QAM, 64QAM, MIMO
Transmission speed* ⁸	IEEE 802.11b	Up to 11 Mbps
	IEEE 802.11g/a	Up to 54 Mbps
	IEEE 802.11n	Up to 300 Mbps
Operating range* ⁷		Approx. 30 m (98 ft 5 in)
Frequency range	IEEE802.11a/n	5.18–5.85 GHz
	IEEE802.11b/g/n	2.4GHz
Security	Infrastructure mode	WPA-PSK (TKIP/AES), WPA2-PSK (TKIP/AES), WEP (128 bit/64 bit), WPA-EAP/WPA2-EAP (PEAP [MS-CHAPv2/GTC], EAP-FAST [MS-CHAPv2/GTC], EAP-TTLS [MD5/MS-CHAPv2])

Wireless Manager ME 6.2 system requirements	To use network functions, a PC is required that meets the conditions given below.
OS	Microsoft® Windows Vista®: Ultimate 32-bit/64-bit, Business 32-bit/64-bit, Home Premium 32-bit/64-bit, Home Basic 32-bit/64-bit Windows® 7: Ultimate 32-bit/64-bit, Professional 32-bit/64-bit, Home Premium 32-bit/64-bit Windows® 8: Windows® 8 Pro 32-bit/64-bit, Windows® 8 32-bit/64-bit Windows® 8.1: Windows® 8.1 32-bit/64-bit, Windows® 8.1 Pro 32-bit/64-bit Apple Mac OS X*9: v10.6, v10.7, v10.8, v10.9
Web browser	Windows®: Internet Explorer 7.0/8.0/9.0/10.0/11.0 Mac OS: Safari 3.0/4.0/5.0/6.0/7.0
CPU	Intel® Core™ i5 or higher, or other compatible processor
Memory	1024 MB or more
Free hard disk space	100 MB or more
CD-ROM drive	CD-ROM drive or DVD drive (required for installation)
Wireless LAN	IEEE 802.11b/g/n compatible (built-in wireless LAN system or external IEEE 802.11b/g/n LAN card must be installed and running normally.) NOTE: Wireless connection may not be possible with some IEEE 802.11b/g/n wireless LAN systems. Macintosh computers must have a built-in wireless LAN adapter. For IEEE 802.11n connection, use a wireless LAN adapter, projector and access point that are IEEE 802.11n compatible, and connect with Infrastructure mode.
Wired LAN connector	RJ-45 (10BASE-T/100BASE-TX/1000BASE-T)

Supplied accessories

- Wireless remote control unit (× 1)
- Power cord (2 m*) (× 1)
- *PT-VZ575ND(for India) : 3.0 m
- Software CD-ROM (Operating instructions, Wireless Manager ME 6.2, Multi Projector Monitoring and Control Software, Logo Transfer Software) (× 1)
- Batteries for remote control (R03/LR03/AAA type× 2)
- Computer cable (1.8 m) (× 1)
- Lens cap (× 1)

Optional accessories

Digital interface box	ET-YFB100G
Easy Wireless Stick	ET-UW100*10
Ceiling mount bracket	ET-PKL100H (for high ceilings)
Ceiling mount bracket	ET-PKL100S (for low ceilings)
Projector Mount Bracket	ET-PKV400B
Replacement lamp unit	ET-LAV400
Replacement filter unit	ET-RFV400
Early Warning Software	ET-SWA100
D-SUB - S Video conversion cable	ET-ADSV

Weights and dimensions shown are approximate. Specifications subject to change without notice.

- *1 When the Standby mode is set to Eco, network functions such as power on over the LAN network will not operate. Also, only certain commands can be received for external control using the serial terminal.
- *2 Measurement, measuring conditions, and method of notation all comply with ISO 21118 international standards.
- *3 Only compatible with dot clock frequency of 27 MHz (pixel repetition signal)
- *4 With legs at shortest position.
- *5 Include protruding parts.
- *6 Average value. May differ depending on models.
- *7 Operation range differs depending on environments.
- *8 This is a theoretical speed. The actual transfer speed varies depending on the usage environment and connected devices.
- *9 The operation system must be pre-installed at the factory or clean installed.
- *10 The ET-UW100 is available in the following countries and regions as of May 2014: North America, England, Germany, France, Spain, Italy, Belgium, Austria, Sweden, Norway, Denmark, Switzerland, Holland, Finland, Portugal, Greece, and Australia.

Dimensions

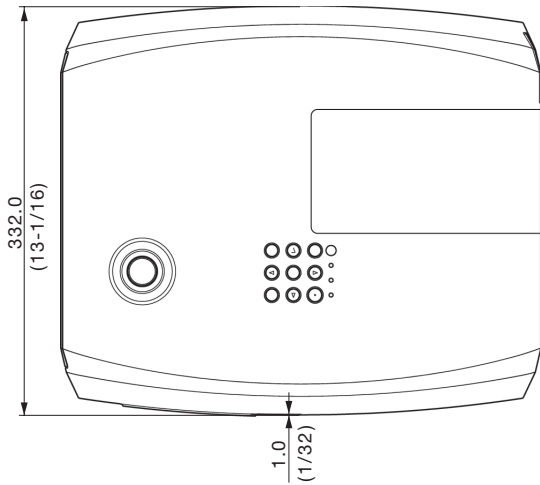

unit : mm (inch)

NOTE: This illustration is not drawn to scale.

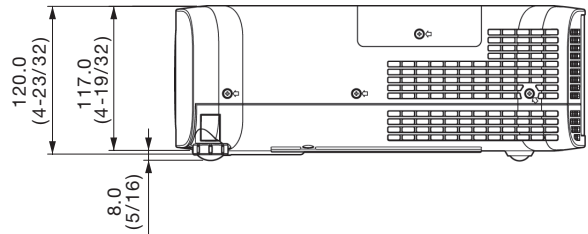
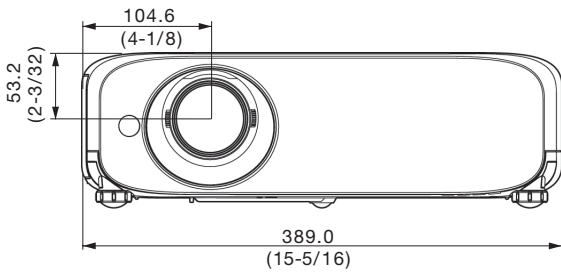

Terminals

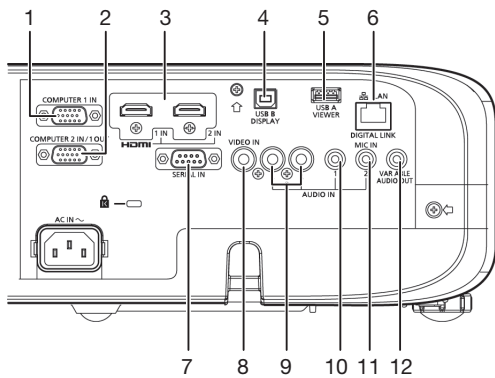

- 1 Computer 1 input
- 2 Computer 2 input / computer 1 output
- 3 HDMI input
- 4 USB B connector
- 5 USB A connector
- 6 LAN / DIGITAL LINK connector
- 7 Serial input
- 8 Video input
- 9 Audio input 3
- 10 Audio input 1
- 11 Audio input 2
- 12 Audio output

Standard setting-up position

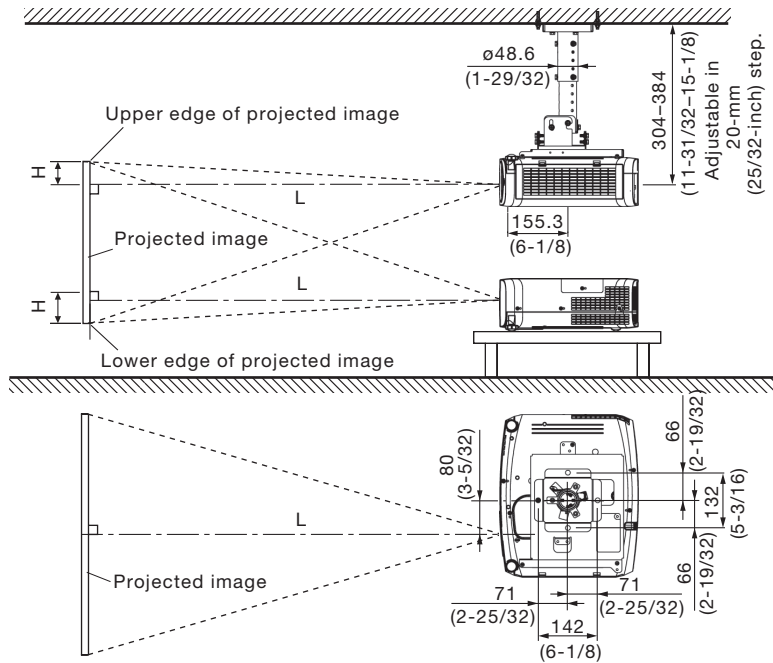

NOTE:

Illustrations show the projector installed using optional ceiling mount bracket ET-PKL100H and projector mount bracket ET-PKV400B.

This illustration is not drawn to scale.

unit : mm (inch)

Caution:

- All construction work should be done by a qualified technician.
- When mounting to the ceiling, use the special mounting bracket. To prevent the projector from dropping, attach the wire that is included with the projector between the mounting bracket and the ceiling.

Projection distance for 16:10 aspect ratio screen

unit: meters (feet)

Projection size [diagonal]	Projection distance [L]		Height from the edge of screen to center of lens [H]
	Min [wide]	Max [telephoto]	
0.76 m / 30"	0.7 (2.2)	1.1 (3.7)	0.02 – 0.20 (0.07 – 0.66)
1.02 m / 40"	0.9 (3.0)	1.5 (4.9)	0.03 – 0.27 (0.10 – 0.88)
1.27 m / 50"	1.2 (3.8)	1.9 (6.2)	0.04 – 0.34 (0.12 – 1.11)
1.52 m / 60"	1.4 (4.6)	2.3 (7.5)	0.05 – 0.40 (0.15 – 1.33)
1.78 m / 70"	1.6 (5.4)	2.7 (8.7)	0.05 – 0.47 (0.17 – 1.55)
2.03 m / 80"	1.9 (6.2)	3.0 (10.0)	0.06 – 0.54 (0.20 – 1.77)
2.29 m / 90"	2.1 (6.9)	3.4 (11.2)	0.07 – 0.61 (0.22 – 1.99)
2.54 m / 100"	2.4 (7.7)	3.8 (12.5)	0.08 – 0.67 (0.25 – 2.21)
3.05 m / 120"	2.8 (9.3)	4.6 (15.0)	0.09 – 0.81 (0.30 – 2.65)
3.81 m / 150"	3.5 (11.6)	5.7 (18.8)	0.11 – 1.01 (0.37 – 3.31)
5.08 m / 200"	4.7 (15.5)	7.6 (25.1)	0.15 – 1.35 (0.49 – 4.42)
6.35 m / 250"	5.9 (19.4)	9.6 (31.4)	0.19 – 1.68 (0.61 – 5.52)
7.62 m / 300"	7.1 (23.3)	11.5 (37.7)	0.22 – 2.02 (0.73 – 6.62)

NOTE:

- The value for L (distance to screen) varies slightly depending on the zoom lens characteristics.
- At the shortest projection distance, the zoom lens characteristics may cause slight image distortion.

Projection distance for 16:9 aspect ratio screen

unit: meters (feet)

Projection size [diagonal]	Projection distance [L]		Height from the edge of screen to center of lens [H]
	Min [wide]	Max [telephoto]	
0.76 m / 30"	0.7 (2.3)	1.2 (3.8)	0.00 – 0.19 (0.01 – 0.61)
1.02 m / 40"	1.0 (3.1)	1.5 (5.1)	0.00 – 0.25 (0.01 – 0.82)
1.27 m / 50"	1.2 (3.9)	1.9 (6.4)	0.00 – 0.31 (0.01 – 1.02)
1.52 m / 60"	1.4 (4.7)	2.3 (7.7)	0.01 – 0.37 (0.02 – 1.23)
1.78 m / 70"	1.7 (5.5)	2.7 (8.9)	0.01 – 0.44 (0.02 – 1.43)
2.03 m / 80"	1.9 (6.3)	3.1 (10.2)	0.01 – 0.50 (0.02 – 1.63)
2.29 m / 90"	2.2 (7.1)	3.5 (11.5)	0.01 – 0.56 (0.02 – 1.84)
2.54 m / 100"	2.4 (7.9)	3.9 (12.8)	0.01 – 0.62 (0.03 – 2.04)
3.05 m / 120"	2.9 (9.6)	4.7 (15.4)	0.01 – 0.75 (0.03 – 2.45)
3.81 m / 150"	3.6 (12.0)	5.9 (19.3)	0.01 – 0.93 (0.04 – 3.06)
5.08 m / 200"	4.9 (16.0)	7.8 (25.7)	0.02 – 1.25 (0.05 – 4.08)
6.35 m / 250"	6.1 (20.0)	9.8 (32.2)	0.02 – 1.56 (0.06 – 5.11)
7.62 m / 300"	7.3 (24.0)	11.8 (38.7)	0.02 – 1.87 (0.08 – 6.13)

NOTE:

- The value for L (distance to screen) varies slightly depending on the zoom lens characteristics.
- At the shortest projection distance, the zoom lens characteristics may cause slight image distortion.

Projection distance for 4:3 aspect ratio screen

unit: meters (feet)

Projection size [diagonal]	Projection distance [L]		Height from the edge of screen to center of lens [H]
	Min [wide]	Max [telephoto]	
0.76 m / 30"	0.8 (2.6)	1.3 (4.2)	0.03 – 0.23 (0.08 – 0.75)
1.02 m / 40"	1.0 (3.4)	1.7 (5.6)	0.03 – 0.31 (0.11 – 1.00)
1.27 m / 50"	1.3 (4.3)	2.1 (7.0)	0.04 – 0.38 (0.14 – 1.25)
1.52 m / 60"	1.6 (5.2)	2.6 (8.4)	0.05 – 0.46 (0.17 – 1.50)
1.78 m / 70"	1.9 (6.1)	3.0 (9.9)	0.06 – 0.53 (0.19 – 1.75)
2.03 m / 80"	2.1 (7.0)	3.4 (11.3)	0.07 – 0.61 (0.22 – 2.00)
2.29 m / 90"	2.4 (7.8)	3.9 (12.7)	0.08 – 0.69 (0.25 – 2.25)
2.54 m / 100"	2.7 (8.7)	4.3 (14.1)	0.09 – 0.76 (0.28 – 2.50)
3.05 m / 120"	3.2 (10.5)	5.2 (17.0)	0.10 – 0.91 (0.33 – 3.00)
3.81 m / 150"	4.0 (13.1)	6.5 (21.3)	0.13 – 1.14 (0.42 – 3.75)
5.08 m / 200"	5.4 (17.6)	8.6 (28.4)	0.17 – 1.52 (0.55 – 5.00)
6.35 m / 250"	6.7 (22.0)	10.8 (35.5)	0.21 – 1.91 (0.70 – 6.25)
7.62 m / 300"	8.0 (26.4)	13.0 (42.6)	0.25 – 2.29 (0.83 – 7.50)

NOTE:

- The value for L (distance to screen) varies slightly depending on the zoom lens characteristics.
- At the shortest projection distance, the zoom lens characteristics may cause slight image distortion.

Calculation of the projection distance

For a screen size different from the above, use the equation below to calculate the projection distance.

Aspect ratio 16:10

minimum $L (m) = (\text{diagonal screen size in inches}) \times 0.0238 - 0.0294$

maximum $L (m) = (\text{diagonal screen size in inches}) \times 0.0384 - 0.0319$

Aspect ratio 16:9

minimum $L (m) = (\text{diagonal screen size in inches}) \times 0.0245 - 0.0294$

maximum $L (m) = (\text{diagonal screen size in inches}) \times 0.0394 - 0.0319$

Aspect ratio 4:3

minimum $L (m) = (\text{diagonal screen size in inches}) \times 0.0269 - 0.0294$

maximum $L (m) = (\text{diagonal screen size in inches}) \times 0.0434 - 0.0319$

NOTE:

Distances calculated with the above equations will include a slight error.

Shift range

Optical axis shift function allows to shift the position of a projected image as shown below.

• **Floor mount**

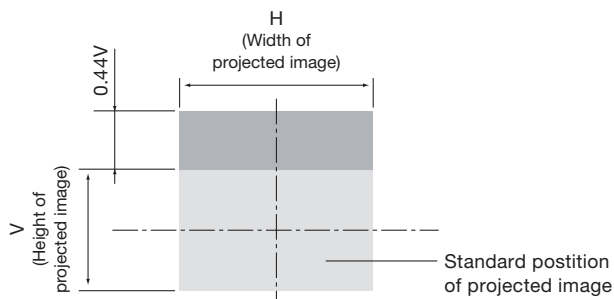

• **Ceiling mount**

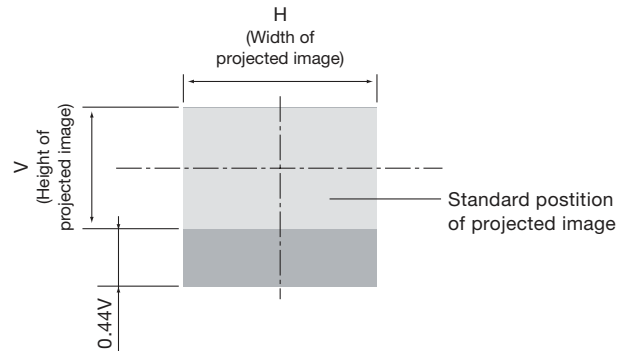

Installable angle

Install the projector at an angle within the range shown below.

• **Vertical direction**

The projector may be installed at a vertical angle of 30°.

• **Horizontal direction**

The projector may be installed at a horizontal angle of 15°.

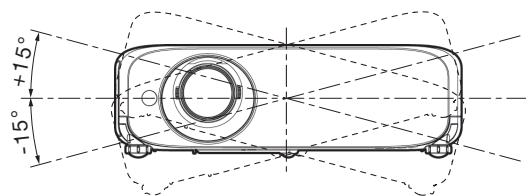
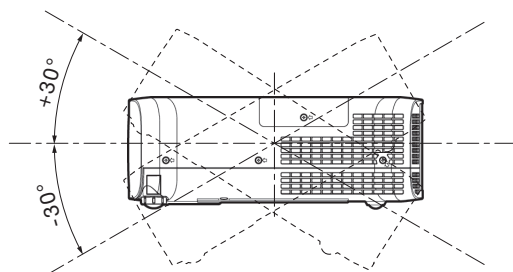

List of compatible signals

The signals that can be input to this projector are shown in the table below. Horizontal scanning frequencies of 15 kHz to 91 kHz, vertical scanning frequencies of 24 Hz to 100 Hz, and a dot clock of 162 MHz maximum can be input.

NOTE: The native resolution of this projector is 1,920 x 1200 pixels. If the display resolution of the input signal is different from the native resolution, image compression or expansion will be used to convert the input signal to a level within the native resolution.

Display mode	Display resolution (dots)*1	Scanning frequency		Dot clock frequency (MHz)	Format
		H (kHz)	V (kHz)		
NTSC/NTSC4.43/PAL-M/PAL60	720 x 480i	15.7	59.9	–	VIDEO
PAL/PAL-N/SECAM	720 x 576i	15.6	50.0	–	
525i (480i)	720 x 480	15.7	59.9	13.5	RGB/YCbCr
625i (576i)	720 x 576i	15.6	50.0	13.5	
525i (480i)	720 (1440) x 480i*2	15.7	59.9	27.0	HDMI
625i (576i)	720 (1440) x 576i*2	15.6	50.0	27.0	
525p (480p)	720 x 483	31.5	59.9	27.0	RGB/YPbPr/HDMI
625p (576p)	720 x 576	31.3	50.0	27.0	
750 (720)/60p	1280 x 720	45.0	60.0	74.3	
750 (720)/50p		37.5	50.0	74.3	
1125 (1080)/60i*3	1920 x 1080i	33.8	60.0	74.3	
1125 (1080)/50i		28.1	50.0	74.3	
1125 (1080)/24p	1920 x 1080	27.0	24.0	74.3	
1125 (1080)/24sF	1920 x 1080i	27.0	48.0	74.3	
1125 (1080)/25p	1920 x 1080	28.1	25.0	74.3	
1125 (1080)/30p		33.8	30.0	74.3	
1125 (1080)/60p		67.5	60.0	148.5	
1125 (1080)/50p		56.3	50.0	148.5	
640 x 400	640 x 400	31.5	70.1	25.2	
		37.9	85.1	31.5	
VGA	640 x 480	31.5	59.9	25.2	
		35.0	66.7	30.2	
		37.9	72.8	31.5	
		37.5	75.0	31.5	
		43.3	85.0	36.0	
SVGA	800 x 600	35.2	56.3	36.0	
		37.9	60.3	40.0	
		48.1	72.2	50.0	
		46.9	75.0	49.5	
		53.7	85.1	56.3	
MAC16	832 x 624	49.7	74.6	57.3	
XGA	1024 x 768	39.6	50.0	51.9	
		48.4	60.0	65.0	
		56.5	70.1	75.0	
		60.0	75.0	78.8	
		65.5	81.6	86.0	
		68.7	85.0	94.5	
		81.4	100.0	113.3	
1152 x 864	1152 x 864	53.7	60.0	81.6	
		67.5	74.9	108.0	
		77.1	85.0	119.7	
MAC21	1152 x 870	68.7	75.1	100.0	
1280 x 720	1280 x 720	37.1	50.0	60.5	
		44.8	60.0	74.5	

*1 The "i" appearing after the resolution indicates an interlaced signal.
 *2 Only compatible with dot clock frequency of 27 MHz (pixel repetition signal)
 *3 When a 1125 (1035)/60i signal was input, it is displayed as a 1125 (1080)/60i signal.

Display mode	Display resolution (dots) ^{*1}	Scanning frequency		Dot clock frequency (MHz)	Format
		H (kHz)	V (kHz)		
1280 x 768	1280 x 768	60.3	74.9	102.3	RGB/HDMI
		68.6	84.8	117.5	
1280 x 800	1280 x 800	41.3	50.0	68.0	
		49.7	59.8	83.5	
		62.8	74.9	106.5	
		71.6	84.9	122.5	
1280 x 960	1280 x 960	60.0	60.0	108.0	
SXGA	1280 x 1024	64.0	60.0	108.0	
		80.0	75.0	135.0	
		91.1	85.0	157.5	
1366 x 768	1366 x 768	39.6	49.9	69.0	
		47.7	59.8	85.5	
1400 x 1050	1400 x 1050	65.2	60.0	122.6	
		65.3	60.0	121.8	
		82.2	75.0	156.0	
1440 x 900	1440 x 900	55.9	60.0	106.5	
1600 x 900	1600 x 900	46.3	50.0	97.0	
		55.9	60.0	119.0	
UXGA	1600 x 1200	75.0	60.0	162.0	
1680 x 1050	1680 x 1050	54.1	50.0	119.5	
		65.3	60.0	146.3	
1920 x 1080	1920 x 1080	55.6	49.9	141.5	
	1920 x 1080 ^{*2}	66.6	59.9	138.5	
	1920 x 1080 ^{*3}	67.2	60.0	173.0	RGB
WUXGA	1920 x 1200	61.8	49.9	158.3	RGB/HDMI
	1920 x 1200 ^{*2}	74.0	60.0	154.0	
	1920 x 1200 ^{*3}	74.6	59.9	193.3	RGB

*1 The "i" appearing after the resolution indicates an interlaced signal.
 *2 Compliant with VESA CVT-RB (Coordinated Video Timing-Reduced Blanking).
 *3 The image processing circuit reduces the number of pixels to display images.

NOTE: DIGITAL LINK and HDMI inputs share the same compatible signal.

Notes on projector placement and operation

The projector uses a high-wattage lamp that becomes very hot during operation. Please observe the following precautions.

1. Never place objects on top of the projector while it is operating.
2. Make sure there is the unobstructed space as shown below or more around the projector's exhaust openings. In addition to this space, also ensure that there is a sufficient work space for removing and installing the lamp, filter and other parts.
3. Make sure that nothing blocks the projector's air intake and exhaust openings. Also, install the projector so that cool or hot air from other air conditioning equipment does not flow directly toward the projector's air intake or exhaust openings.
4. Do not install the projector in an enclosed space. If it is necessary to install it in an enclosed space, add a separate ventilation system. If ventilation is insufficient, hot air will accumulate at the intake opening. This may cause the projector's protective circuit to interrupt projector operation.

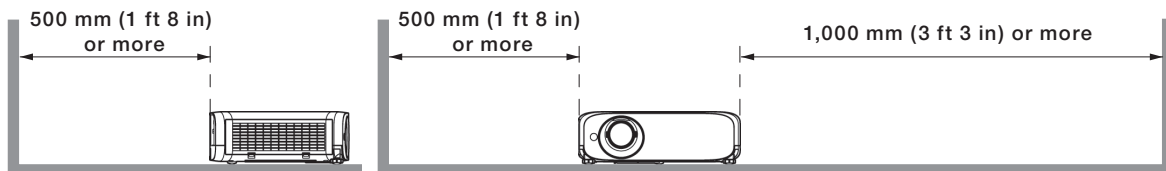

Direction of air intake and exhaust

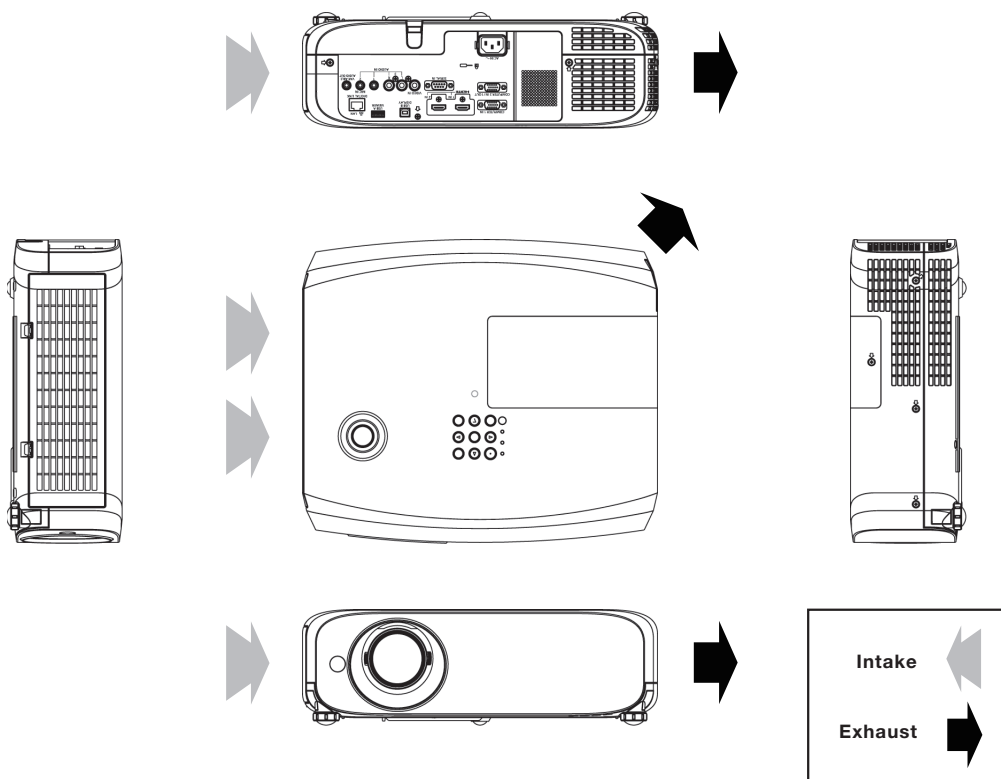

Operating the projector continuously

1. If the projector is to be operated continuously 12 hours or more, lamp replacement cycle duration becomes shorter.
2. The lamp replacement cycle duration becomes shorter if the projector is operated repeatedly for short periods (one hour or less).

Weights and dimensions shown are approximate. Specifications and appearance are subject to change without notice.
Product availability differs depending on region and country. This product may be subject to export control regulations.

HDMI, the HDMI logo and High-Definition Multimedia Interface are trademarks or registered trademarks of HDMI Licensing LLC in the United States and other countries.
PJLink is a registered trademark, or a trademark application has been filed, in Japan, the United States, and other countries and regions.
All other trademarks are the property of their respective trademark owners.

HDBaseT™ is a trademark of the HDBaseT Alliance.